



*MONITORING, DATA LOGGING AND
CONTROL SYSTEM
MS55*

INSTRUCTION MANUAL
Basic Part

CONTENT:

page

INTRODUCTION	3
1. GENERAL SAFETY PRECAUTIONS	5
2. WIZARD for INSTALLATION and CONFIGURATION of DATA LOGGER.....	5
3. RULES for MOUNTING and CONNECTION of DATA LOGGER	7
3.1. Mechanical location of data logger and the way of cable routing.....	7
3.2. Data logger interface connectors	11
3.3. Mounting and connection of output relays module MP018	13
3.4. Mounting and connection of external terminal with display.....	14
3.5. Connection of data logger to the computer	14
3.6. Connection of data logger with support of SMS messaging	16
3.7. Connection of data logger to power	16
4. CONTROL and INDICATION COMPONENTS of DATA LOGGER.....	17
5. USER PROGRAM FOR DATA LOGGER.....	23
5.1. Program features.....	23
5.2. Installation of program	23
5.3. Setting of communication with data logger	23
5.4. Basic items in menu program	24
6. DESCRIPTION of CONFIGURATION and DATA LOGGER MODES	25
6.1. Bookmark <i>Common</i>	25
6.2. Bookmark <i>Communication</i>	25
6.3. Bookmark <i>Profile</i>	27
6.4. Bookmark <i>Ch.. Identity & Calculations</i>	28
6.5. Bookmark <i>Ch.. Measuring & recording</i>	28
6.6. Bookmark <i>Ch..Conditions</i>	31
6.7. Bookmark <i>Ch..Alarms and indication</i>	36
7. APPLICATION NOTES.....	37
7.1. <i>Processes and how to work with</i>	37
7.2. <i>SMS message and how to work with</i>	37
7.3. <i>Possibilities of setting Logging interval</i>	38
7.4. <i>Identification of person, who deactivated alarm</i>	38
7.5. <i>Way of entering PIN code from data logger keyboard</i>	38
7.6. <i>Sharing of Display mode on several computers together with automatic storing of data on network</i>	39
7.7. <i>How to ensure alarm report, in case of power failure</i>	39
7.8. <i>Back-up of data logger configuration and its restoring</i>	39
7.9. <i>How to set variable condition limit according to measured value on other channel?.....</i>	39
7.10. <i>Can be confirmation of alarm signalization applied to acoustic alarm only?.....</i>	39
7.11. <i>It is possible to force confirmation of alarm signalization again after some time?.....</i>	39
7.12. <i>What is it "latched alarms"?</i>	40
7.13. <i>Other possibilities in data logger configuration</i>	40
7.14. <i>What to do if data logger does not work</i>	40
7.15. <i>Self test error</i>	40
7.16. <i>Problems with correct measurement</i>	40
7.17. <i>Problems in communication with computer</i>	41
8. RECOMMENDATION FOR OPERATION AND MAINTENANCE.....	42
9. TECHNICAL DESCRIPTION AND PARAMETERS OF DATA LOGGER	44

Note: Manual Appendixes are available in electronic pdf format at www.cometsystem.com.

INTRODUCTION

Data loggers are designed for measurement, record, evaluation and consequent processing of input electrical signals, characterized by relatively slow changes ($>1s$). Together with proper transmitters and transducers are suitable for monitoring of physical values.

Device enables:

- to measure and process 1 to 16 input signals
- to acquire autonomous time record of measured values
- create alarm states
- to perform other actions based on created alarms (audible, visual indication, controlling of relay outputs, sending SMS message, controlling of telephone dialer, sending of messages via several protocols of the Ethernet interface etc.)
- to monitor on-line measured values and states

The basic model is data logger MS55D.

Drawing (MS55D):

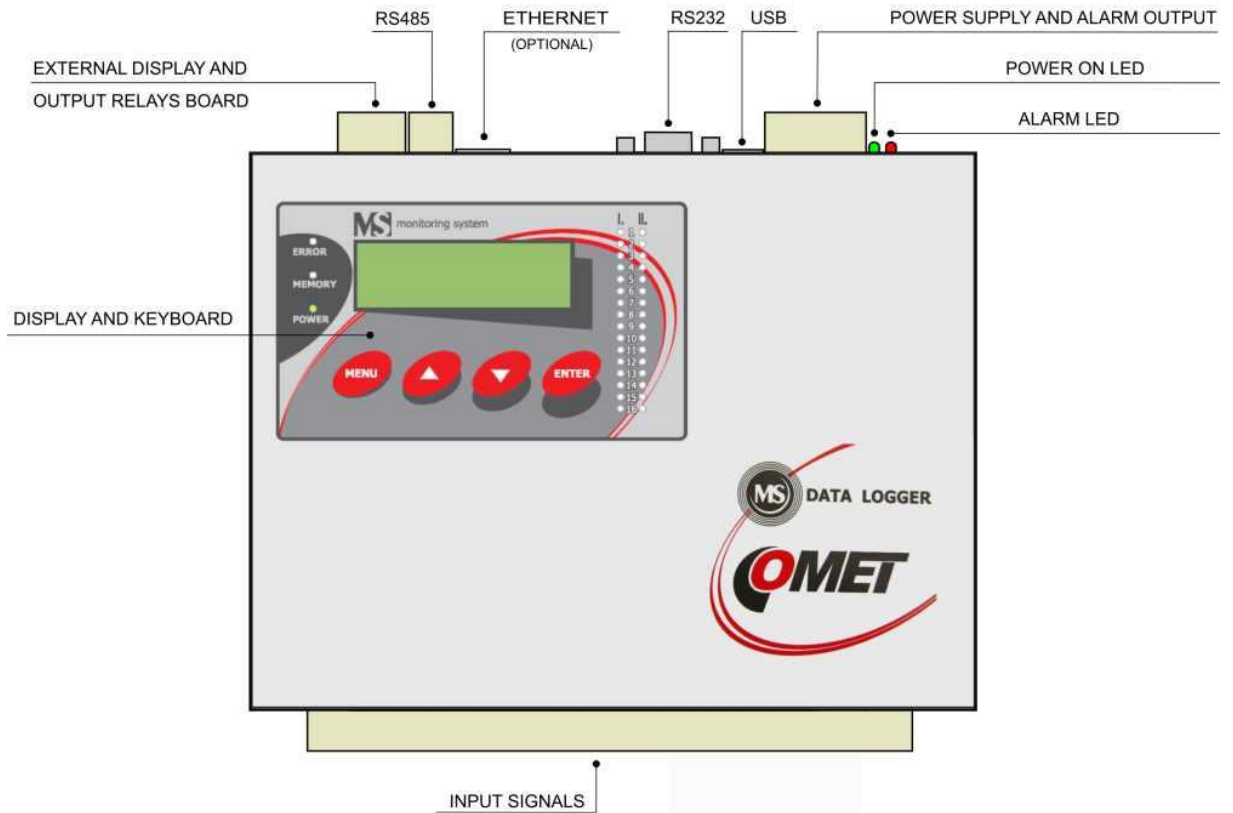

Items marked Accessory are not included in delivery and it is necessary to order separately.

Architecture of measuring system with data logger MS55D:

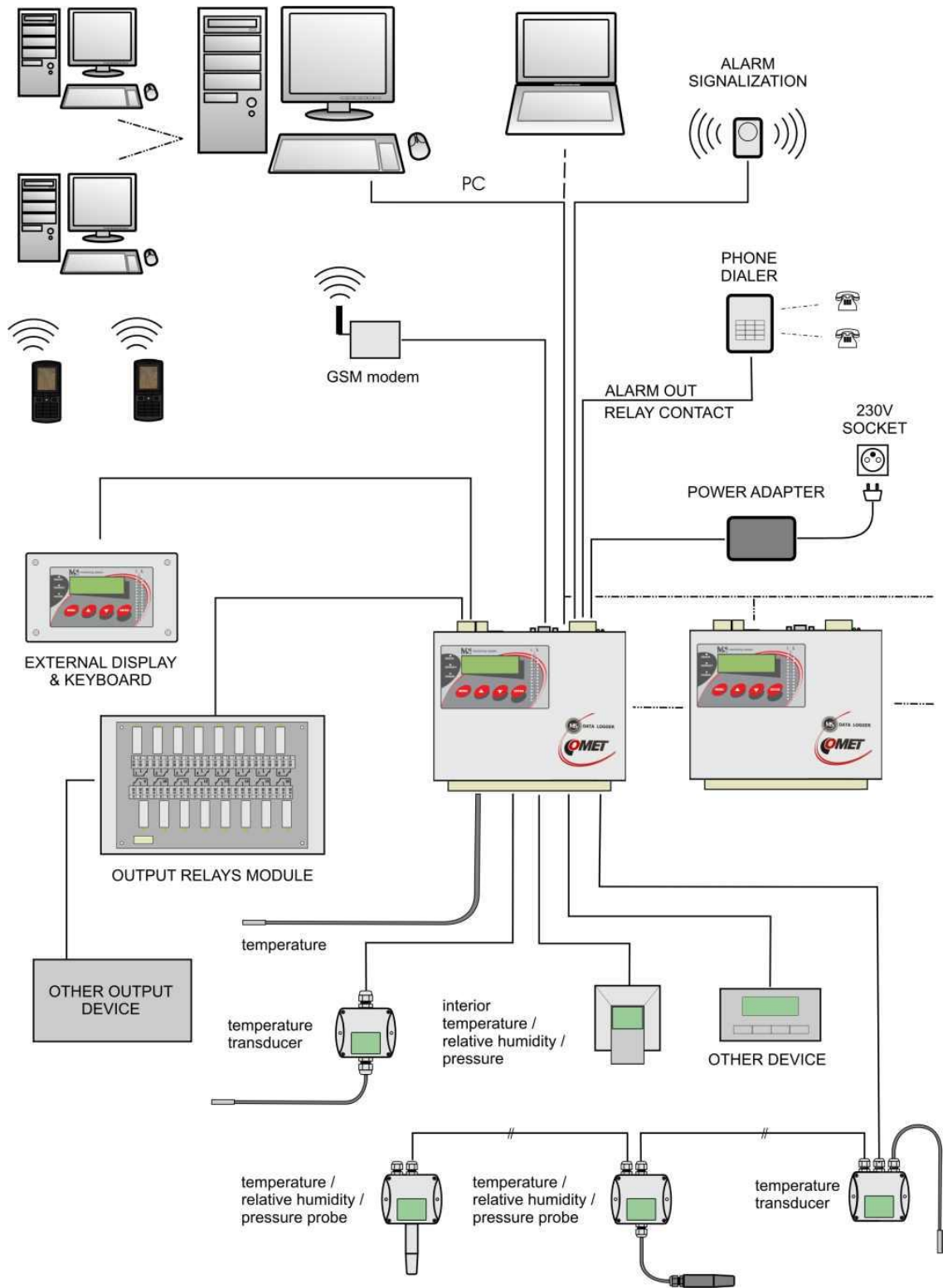

1. GENERAL SAFETY PRECAUTIONS



The following list of precautions serves to reduce risk of injury or damage of described instrument. To prevent injuries use instrument accordingly with rules in this manual.

- Follow rules specified in part [Not allowed manipulations and notice](#)
- Installation and service need to be performed only by qualified person.
- Use suitable power source. Use only source with power voltage recommended by the manufacturer and approved in accordance with proper standards. Pay attention, the source has undamaged cables or cover.
- Connect and disconnect correctly. Do not connect and disconnect cables, if device is under electrical voltage.
- Do not use instrument without covers. Do not remove covers.
- Do not use instrument, if it does not work correctly. If you mean instrument does not correctly, let it check by qualified service person.
- Do not use instrument in environment with danger of explosion.

2. WIZARD for INSTALLATION and CONFIGURATION of DATA LOGGER

2.1.1 Mounting of data logger and its accessory

- Select suitable location for placing data logger – pay attention to parameters of ambient environment, minimize the number of cables, avoid sources of interference
- Mounting of sensors and routing of cables – pay attention to rules of theirs installation, use recommended working positions, avoid devices and distribution of power electricity
- Check proper connection – before first switching on. If data logger controls other actuating devices of regulation, it is recommended to put them out of operation before configuration of data logger.

*Basic rules for mounting of data logger are described in chapter [RULES for MOUNTING and CONNECTION DATA LOGGER](#). Detailed information on different connections to the PC are described in *Appendix No. 4* in electronic version.*

2.1.2 Basic activation of data logger

- Connection of data logger to power - connect data logger to power and visually check its function (indication of power, optionally the display and keyboard)
- Installation of software - install user program to the PC (see part [PROGRAM for DATA LOGGER](#))

Configuration of data logger communication with computer – in user SW in part Configuration-Setting of communication configure and test the data logger connection to computer. Basic description of Setting of communication interface is in chapter [RULES for MOUNTING and CONNECTION of DATA LOGGER](#). Detailed description is in *Appendix No. 4* in pdf format.

Program enables to work simultaneously with several data loggers, that are connected to the computer in different ways.

2.1.3 Configuration of data logger – read and change the data logger configuration by means of the SW in part Configuration – Configuration of data logger (icon **i**). Detailed description of data logger configuration is in part [DESCRIPTION of CONFIGURATION and MODES of DATA LOGGER](#).

- set data logger Name, Date and Time in data logger
- specify *Type and range* of input channel
- assign names to each measured point and optimize the display for your requirements (signal conversions, decimal point position etc.)
- switch on each input channel needed and set record function:
 - on channels where recorded value with fixed interval is required, use Continuous record with fixed interval.
 - if record with fixed interval only under certain conditions is required, use Conditional record.
 - if only values and time under defined conditions are required, use Sampled record
 - each type of record can be limited in time
 - different record modes can be combined
- if needed set alarm functions
 - first define conditions for consequent actions
 - assign to each alarm conditions for creation of alarm
 - assign to each alarm actions to be performed in alarm creation (lightening of LED diode on data logger panel, activation of ALARM OUT output, activation of audible indication, sending SMS message, sending e-mail etc.)
 - maximum four conditions and two different alarm actions on one channel can be defined; if there is a need for one channel to link several alarms (maximum four), it is enabled to use available alarms from different channels
 - activity of output ALARM-OUT can be cancel by the user directly from data logger or remotely, at the same time it is possible to record it (including information on way of canceling)
 - changes of state for each alarms can be recorded separately
- if there is a need during data logger operation to describe from its keyboard parts of record with predefined notes, it is enabled by means of Processes.
- MS55 data logger does not enable to switch different configurations from the instrument keyboard during operation. To switch to different configuration use the PC program
- if it is required to secure data transfer and access to data logger and program functions, system of passwords and access rights can be used

Read chapter [APPLICATION NOTES](#), where detailed information on several applications are described.

2.1.4 Usual work with data logger

- reading, viewing, archiving and print/export recorded data from selected data logger or from file on disk
- on-line viewing of measured values – Display mode, enables to watch simultaneously all connected data loggers. This mode can be shared simultaneously on several computers in the network
- performance of actions based on created alarm states

Instructions for regular check and maintenance of data logger are specified in part [RECOMMENDATIONS for OPERATION and MAINTENANCE](#).

3. RULES for MOUNTING and CONNECTION of DATA LOGGER

3.1. Mechanical location of data logger and the way of cable routing

Location of data logger must match the operating conditions and not allowed manipulations.

Working position of data logger:

- data logger MS55D lies on horizontal nonflammable surface ¹⁾
- data logger MS55D is fixed²⁾ by means of mounting consoles on the wall from nonflammable material or at low current switchboard – working position is with input connectors downward

The way of mounting of consoles to data logger and mounting holes dimensions:

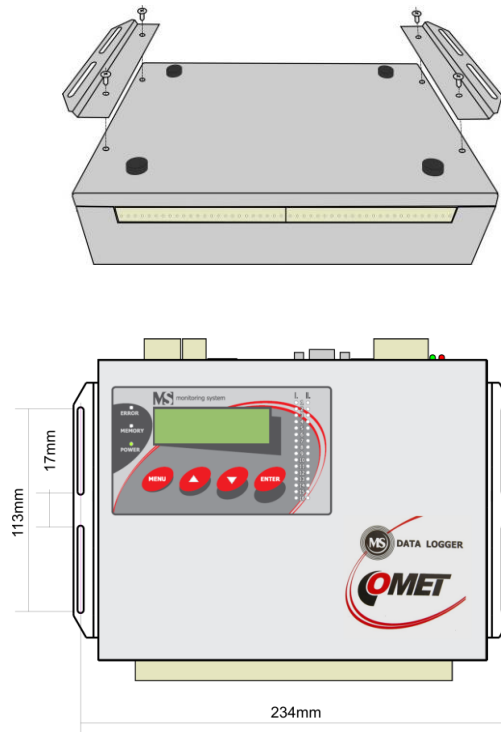

- data logger MS55D is fixed²⁾ by means of the holder on DIN rail at low current switchboard - working position is with input connectors downward

The way of mounting the holder to data logger:

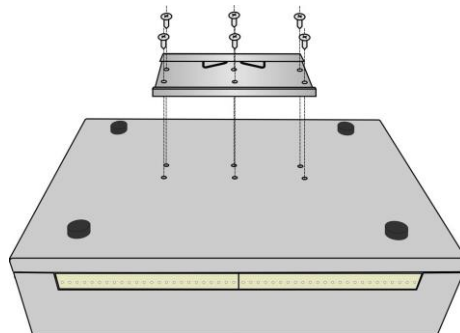

Notes:

¹⁾ horizontal working position for data loggers with thermocouple inputs is not suitable

²⁾ using of the original screws is required (longer screws can damage device)!

Mechanical drawing of MS55D data logger (without cables and connectors):

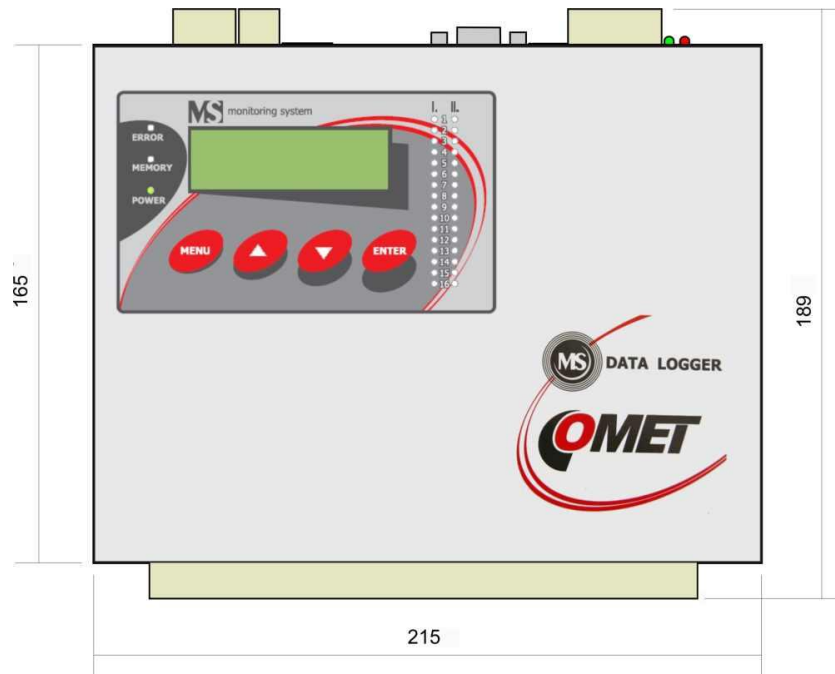

Connection terminals and connectors can be protected by magnetically fixed side covers MP027.

Recommendations for mounting:



Use original included screws to mount side brackets or DIN rail holder. Using longer screws can cause reduction of insulation distance between screws and printed circuit board or short circuits. This can cause system functionality and safety of the users!

- **do not mount data logger near sources of interference** (data logger must not be mounted directly to power switchboard nor to its nearness. Also do not mount data logger near power contactors, motors, frequency converters and other sources of strong interference).

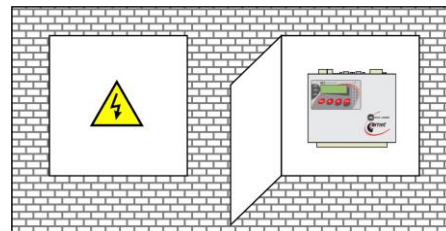
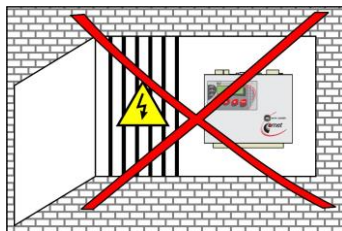

- In cable routing follow rules of standards for installation of low current distribution (EN 50174-2), especially it is necessary to pay attention to avoid electromagnetic interference intrusion to the leads, transmitters, transducers and sensors. Do not locate cabling near sources of interference.

- **Do not use leads in parallel with power distribution network leads**

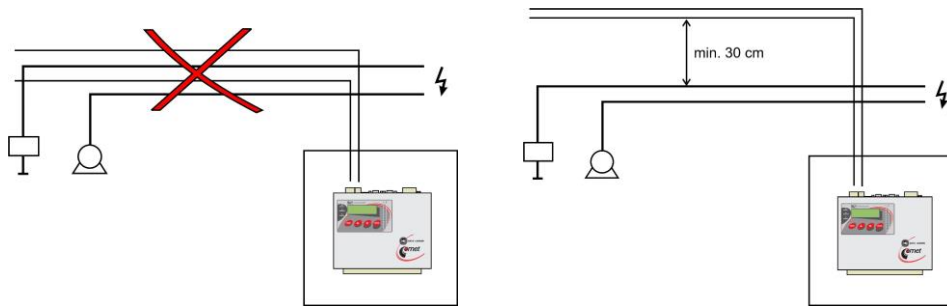

- **Do not use outdoor leads without corresponding protection against effects of static electricity**
- **if not necessary, do not connect system with other circuitry**
- **fundamentally use shielded cables** - e.g. SYKFY n pairs x 0.5, shielding at data logger side connect properly
- **do not create earth loops** - it concerns both measuring circuits and cable shielding.

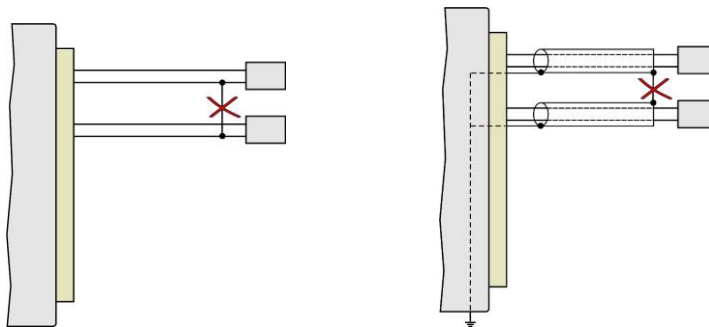

- **do not create hidden earth loops** - do not connect cable shielding at end device side, if these device do not have terminal designed for shielding. Shielding must not be connected to outer metal parts of the device nor with other devices. Do not use shielding as a signal lead.

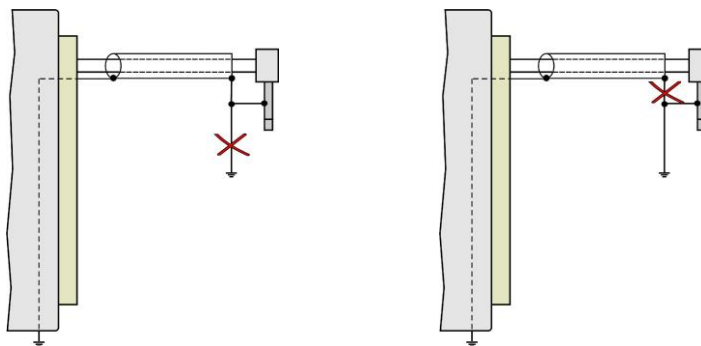

- **Do not use common leads for several channels**

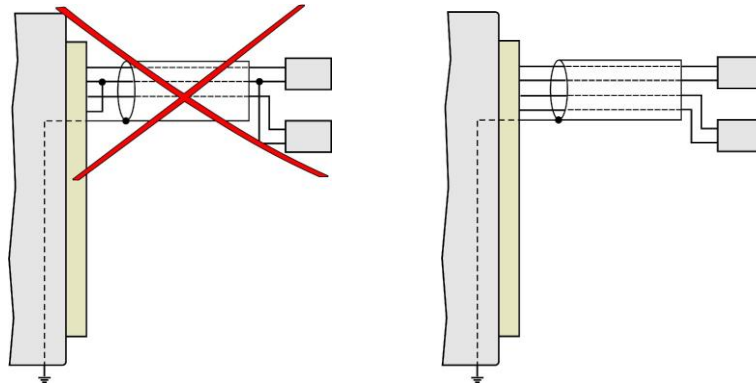

- **It is recommended to earth data logger at one point** – there is a special terminal on power terminal. This earthing will work correctly, if system would not be grounded at other point at the same time.

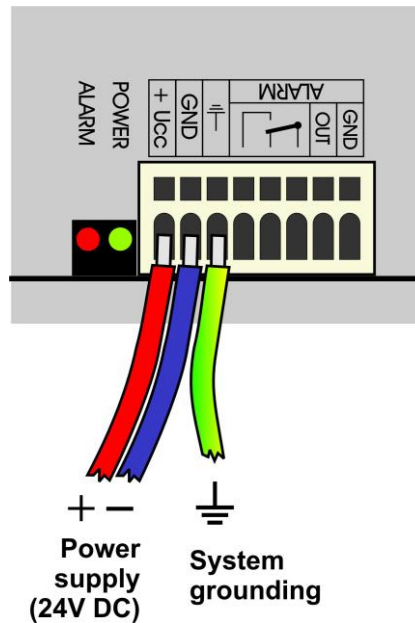

If system is not grounded properly, it is a danger of state, when system floats on variable potential against all other circuitry. It can cause communication dropouts, occasional resets and in extreme case damage of some peripherals. Especially when using pulse power sources (e.g. A1940) it is strongly recommended to ground the system.

3.2. Data logger interface connectors

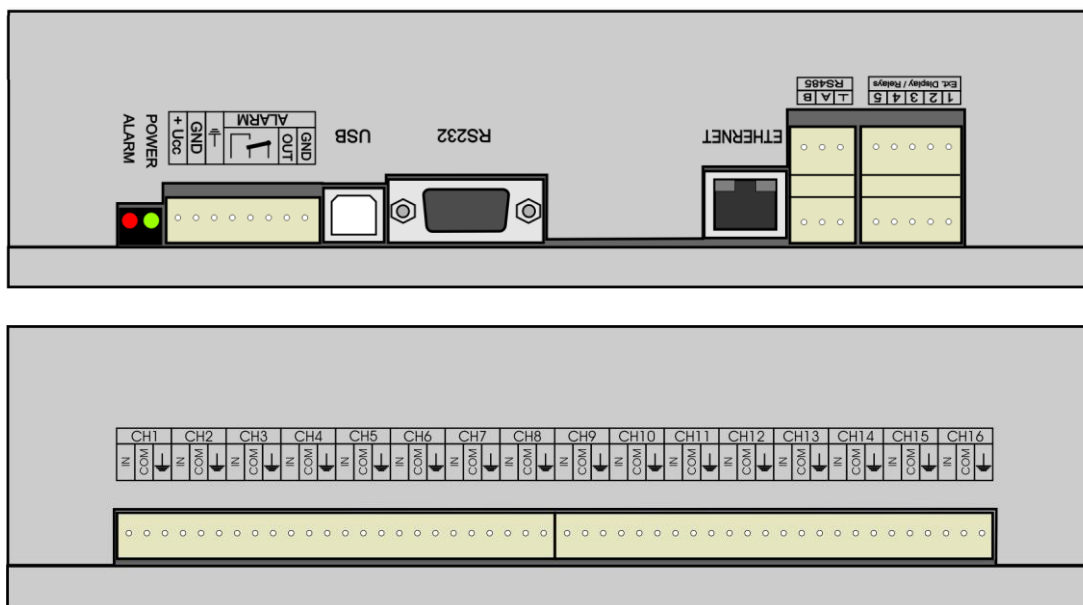

Connectors

Each signal is connected to self-locking terminal WAGO located on the side of the case. Insert flat-bladed screwdriver to rectangle terminal hole and push screwdriver towards away from you - contact is released. Connect wire to released terminal (circular hole behind the rectangular one) and close the terminal by removing the screwdriver.

Notice: The entire input terminal block is possible to remove from data logger by pulling it up from the connector.

Connection of leads:

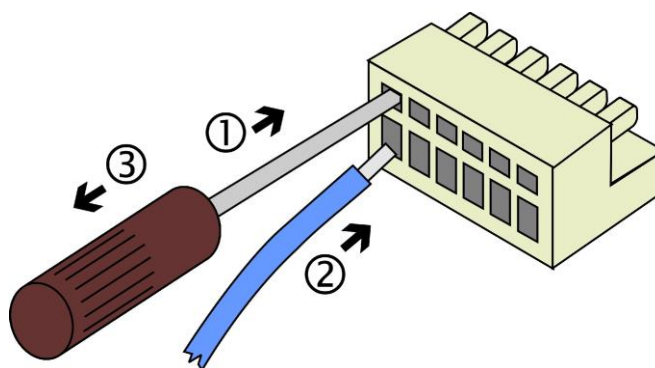

Read [Technical parameters of inputs](#) before connecting input signals

Connection of transducers with current output powered by current loop



In case of connection of channels with current loop powered from data logger (inputs A0) it is possible to insert other devices (panel meters, measuring computer cards, etc.) to current loop. In this case it is necessary to consider if undesirable current coupling will not cause measurement inaccuracy. All inserted devices must be galvanic isolated from other circuits. In case, it is not possible to ensure this, use galvanic isolated inputs A1G and power loops from external source. Connection of input part of the module A0 including connection to two-wire probes is described in *Appendix No. 2*.

Connection of thermocouple probes

For connection of thermocouples use appropriate extension cable. Continuity of material of thermocouple wire should be kept along the line up to data logger connector. Extension (compensation) cable for thermocouples type S (Pt-10 % Rh / Pt) is used from different materials (due cost reasons).

Marking of subminiature thermocouple connectors and wires manufactured by OMEGA (in accordance with US standard):

Thermocouple type	Connector color	+ wire color	- wire color
K (Ni-Cr / Ni-Al)	Yellow	Yellow	Red
J (Fe / Cu-Ni)	Black	White	Red
S (Pt-10 % Rh / Pt)	Green	Black	Red
B (Pt-30 % Rh / Pt-6 % Rh)	Gray	Gray	Red
T (Cu / Cu-Ni)	Blue	Blue	Red
N (Ni-Cr-Si / Ni-Si-Mg)	Orange	Orange	Red



If there are more thermocouple inputs in data logger not galvanic isolated, avoid thermocouples to be mutually connected. If hazard of current leakage exists (mostly between thermocouple welded point and surrounding metal framework), thermocouple probes with galvanic isolated weld from outer probe shield or galvanic isolated input modules should be used. In other case high measuring errors can appear. It is recommended to use shielded thermocouple cables for longer distance (depending on possible interference sources).

Warning - cold junction temperature is sensed at area between channel 8 and channel 9, where the accuracy and the measuring stability is best. If using thermocouples, mind correct data logger working position (vertically, input terminals downward and sufficient ambient air flow). In no case install data logger with thermocouples horizontally or to places with temperature fluctuations. All such circumstances cause undesired temperature fluctuation and influence temperature measurement of thermocouple cold junction and this way also result temperature measurement!

Connection of temperature resistance transducers

- data logger enables only two-wire connection
- choose wires of maximum diameter and minimum length. In *Appendix 7* additional errors caused by leads resistance are specified.
- measurement error caused by wire resistance can be compensated by suitable configuration of data logger

Connection of transmitters with digital output RS485 to RP input module

- For connection of RS485 link for input module RS use e.g. shielded cable 2x2x0.5 mm², where one pair can be used for power of transducers and second pair for link RS485.
- It is recommended to terminate the link by resistor 120 Ω at the beginning and end of the cable.



ATTENTION - it is necessary to connect to one RP module only devices communicating with the same communication speed and the same communication protocol!

Connection of output ALARM OUT

This output is accessible on terminals next to data logger power terminals. Output is dual:

- switching-over galvanically isolated relay contact
- voltage (galvanically connected to data logger)

The output is set from the manufacturer, that in case of selected alarm voltage appears at the output and simultaneously relay closes. It is enabled to set opposite behavior in data logger configuration (then data logger power dropout behaves as alarm state).

Activity of this output can be cancelled from data logger keyboard by the user or remotely from the PC. It is enabled to identify by proper data logger configuration, who cancelled the alarm.

It is possible to connect to this output:

- **External audio indication unit** - use shielded cable up to 100m from data logger. Connect terminal ALARM OUT and GND on data logger with the audio unit in corresponding polarity. Connector CINCH of audio indication unit has positive pole on its central lead.
- **Telephone dialer** – in case of alarm telephone dialer dials specified telephone number and announces voice message. Depending on telephone dialer type use voltage output or relay contact.
- Simultaneously galvanically isolated contact relay can be used for **control of other devices**. If indication controls external circuitry, it is recommended to set delay after activation at least 10 seconds to prevent possible false alerts.
- Mind to adjust suitable delay for proper conditions of alarm creation to prevent possible false alarms.

3.3. Mounting and connection of output relays module MP018

Module contains 16 output relays with switching-over contact, which can be used for control of external devices (see [parameters of relay](#)). It is possible to assign any number of relays to any alarm to be closed if alarm appears. Relays are identified by numbers 1 to 16. Each relay has three self-locking terminals (switching-over contact). Activity of relay can be checked visually on assigned LED diodes.

Relay module is designed for mounting to switchboard with corresponding protection. Fix module (140x211 mm) by means of DIN rail holder MP019 or screw by means of side wall holders MP013 with four suitable screws (mounting holes are identical as for data logger with wall holders MP013, see figure above).



Use original included screws to mount side brackets or DIN rail holder. Using longer screws can cause reduction of insulation distance between screws and printed circuit board or short circuits. This can cause system functionality and safety of the users!

Connect module to data logger with special cable MP017 (see its wiring in *Appendix No. 5* including drawing of connection terminals to this module). Connect module when data logger is switched off! Plug one cable end to corresponding connector on relay module, second end to data logger, connector Ext. Display & Relays (upper or lower connector half can be used, both parts are connected identically). Connect slave device on output terminals of relay. Pay attention to necessary safety (depending on the character of connected device). Relay module must be activated for proper function by means of SW – see *Appendix No. 6*. If data logger is delivered together with this module, function is activated from the manufacturer.

3.4. Mounting and connection of external terminal with display

External terminal with display is designed for visualization of measured values, alarms and for data logger controlling from point up to maximum 50 m from data logger. Its function is identical with internal built-in display of MS55 (keyboard and display work in parallel). The part of the display is also audio indication working analogically as *external audio indication unit* connected to output ALARM OUT.

External terminal is delivered in two versions. As a module prepared for installing to suitable case or in compact case. Module version can be mounted to the lid of light current switchboard or to stand alone case. Cut rectangle opening **156 x 96 mm to the lid**, install terminal module. Insert four screws from front side and screw them to metal holders from the inside. Tighten screws slightly from front side and cover with blinders.

Connect external terminal to data logger with special cable (wiring diagram is specified in **Appendix No. 5**). Connect when data logger is switched off! Follow identical rules for cable routing as for input signals. Plug one cable end to corresponding connector on display unit, second end to data logger, connector Ext. Display & Relays (upper or lower connector half can be used, both parts are connected identically). External terminal must be activated for proper function by means of SW – see **Appendix No. 6**. If data logger is delivered together with this module, function is activated from the manufacturer.

3.5. Connection of data logger to the computer

Data logger contains for communication with computer one internal communication interface, which is separated to several external interfaces. Data logger communicates only via one selected interface:

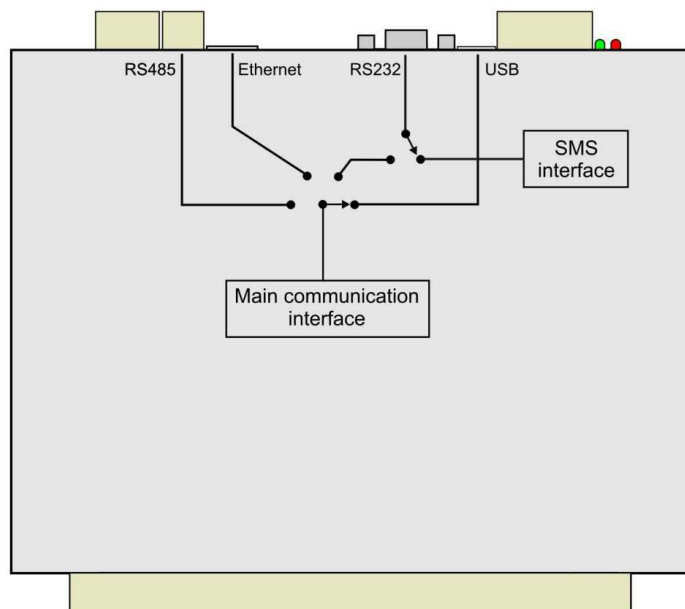

Communication interface can be selected from data logger keyboard or by means of PC program.

In accordance with the way of work with data logger select most suitable way of its connection to the computer:

- a) data logger will be used as a portable device and to computer (e.g. notebook) will be connected only time from time
 - use communication interface USB (up to 5m distance)
- b) data logger is installed close to the computer
 - use communication interface USB up to 5m distance) or

- use communication interface RS232 (up to 15m distance), if computer is equipped with this interface
- c) data logger is far from the computer
- use communication interface RS485 (up to 1200m)
 - use Ethernet network
 - use connection via GSM modems

See **Appendix No.4.** for detailed description of connections, cables, accessories and settings.

Character of communication interfaces:

- a) **communication interface RS232** – connect data logger connector RS232C by cross-over RS232 cable of length up to 15 meters to computer communication port RS232C (COM port).
- + historical, but practically trouble-free communication interface
 - + simple setting
 - some newer computers are not equipped with this interface
- b) **communication interface USB** - connect data logger communication interface USB by means of USB cable A-B of length up to 5 meters to the computer communication port USB
- + practically all newer computers have this interface
 - + relatively easy setting (similarly as RS232)
 - necessary to install suitable drivers, which interpret the device as virtual COM port
 - if data logger is disconnected from the computer often, it is suitable to use always the same USB socket (if using different USB socket operational system can consider as different port and user PC program does not recognize this change)
- c) **communication interface Ethernet** - connect data logger Ethernet interface by means of suitable UTP cable with RJ-45 connector to existing LAN network.
- + practically unlimited distance between data logger and computer
 - + communication and sending alarm messages by means of several network protocols is enabled
 - + mostly it not necessary to build other cabling
 - higher interface price
 - it is necessary to cooperate with network administrator (address allocation, ...)
 - more difficult trouble shooting
- d) **communication interface RS485** – connect data loggers and the computer to the RS485 bus (max. 1200m).
- + network is autonomous, operation is not dependent on third parties
 - + up to 32 data loggers can be connected to one RS485 network
 - special independent cabling must be routed, higher labour consumption and price
 - external converter must be used at computer side to connect computer
- e) **RS232 communication interface with GSM modem for work with data logger and for SMS messages** – connect data logger communication interface RS232C to preconfigured GSM modem, second modem will be at computer side
- + practically unlimited distance between computer and data logger (depend on coverage of operator signal)
 - + SMS messages can be used
 - communication and SMS messages are charged by the GSM operator
 - operation reliability depends on third party

There must be GSM modem also at the computer side and data logger must be configured to communication interface RS232. Then all usual communications can be performed by means of user program via GSM network. Also SMS messaging can be used. Testing of incoming SMS messages and sending of alarm SMS messages is performed with the 2 minutes interval, if data connection is not active. If there is an active connection, SMS messages are not received and sent until connection is deactivated.

3.6. Connection of data logger with support of SMS messaging

Connect data logger communication interface RS232C to preconfigured GSM modem.

Case when GSM modem is used not only for SMS messages, but also for communication with data logger is described above. If data logger is connected to the computer by means of different interface than RS232, GSM modem can be connected to RS232 connector and used for SMS messaging. For detailed description see *Appendix No. 4*.

3.7. Connection of data logger to power

Data logger is powered from suitable power source (can be ordered). When powered from a different source it is necessary to use dc voltage at range specified in technical parameters of data logger. Data logger consumption in different variations is specified in *Appendix No. 1*. Appendix No. 1 describes also several possibilities of data logger power back-up.

4. CONTROL and INDICATION COMPONENTS of DATA LOGGER

4.1. Indication of power and state of output ALARM OUT

Indication is performed visually by LED diodes located at case side next to power terminals (*see Drawing*). Green LED indicates the presence of power voltage, red LED activity of output ALARM OUT.

4.2. Display and keyboard

Left from display are three indication LED diodes:

- Power - indication of presence of power voltage
- Memory (orange) - indication of exceeding of adjusted memory occupation limit
- Error – lights, if configuration violence of data logger appears or error in self test appears

Display is dual line, display can be controlled by means of four button keyboard located next below it (buttons MENU,▲,▼,ENTER). After connection of data logger to power self test of several internal voltages is performed first. If everything correct, data logger starts to display values.

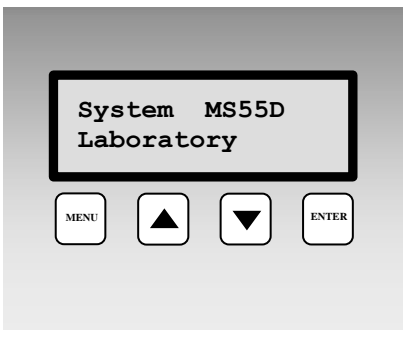
	<p>Display after connection power to data logger. <u>Datalogger model</u> and <u>name</u> is displayed for several seconds. Then data logger evaluates self test of internal voltages. If everything correct, data logger starts to display values. If self test is not correct, data logger reports Self Test Error with specified voltage, which is not correct (power voltage, internal battery and source of negative voltage). The failure is necessary to fix. If specified error message is confirmed by pressing ENTER key, data logger goes on to basic display.</p>
--	--

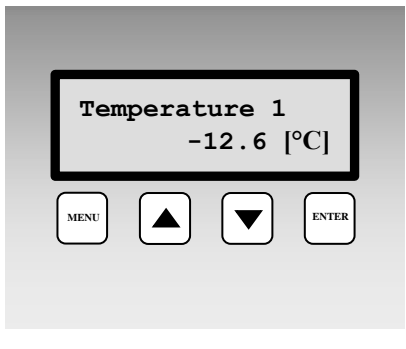
	<p>Basic display on the LCD In basic display upper line displays user specified name of measuring point, adjusted from user program. Lower line displays measured value with physical unit respective state of input channel. All active channels can be checked by keys ▲,▼. Error message can occur instead of measured value. Binary inputs display at the whole LCD bottom line user defined description of state closed/open. In case value is not available or is not correct error message is displayed – see <i>Appendix No. 8</i>.</p>
---	--

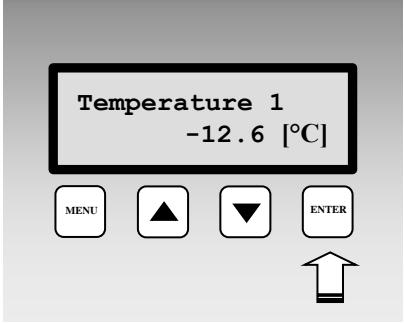
	<p>Deactivation of audible alarm signalization and output ALARM OUT by pressing ENTER key</p> <p>If is this function is enabled, then in basic display of measured values short pressing of this key deactivates audible indication and ALARM OUT output optionally. In case another alarm appears with requirement for audible indication, alarm will be activated. Similarly, if data logger deactivates alarm, which activated audible indication and consequently this alarm appears again, it is activated.</p> <p><i>Other options for deactivation of alarm signalization are specified in Application notes.</i></p>
---	---

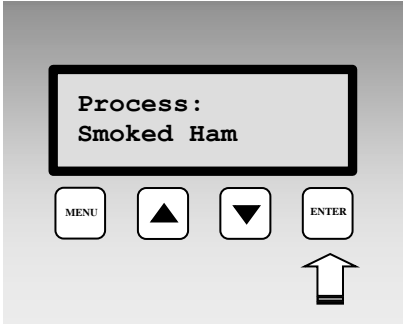
	<p>Display of adjusted process</p> <p>If using <i>Processes</i>, shortly press ENTER key in basic display mode on required channel to display actual process in progress.</p>
---	--

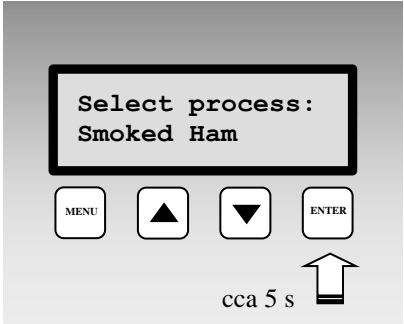
	<p>Selection of new process</p> <p>If using <i>Processes</i>, press and hold for about 5s ENTER key in basic display to enter selection of preset processes. Use ▲, ▼ keys to go through process names enabled for input channel. If no process is needed use selection No process. Press ENTER key to activate selected process.</p> <p>Press MENU key to leave the display without storing new process.</p>
---	--

Items and function available in Menu data logger

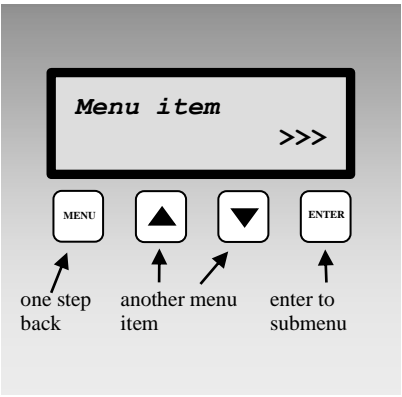
	<p>Press MENU key in basic display to enter the data logger Menu. Use ▲, ▼ keys to go through all menu items. Press MENU key to leave menu to the basic display.</p>
---	--

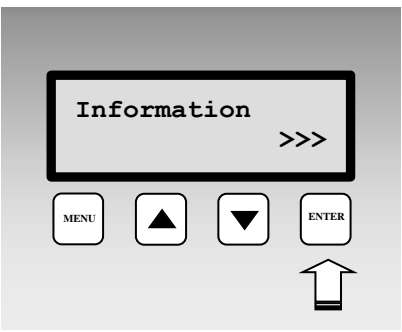
	<p>Menu item Information</p> <p>Item Information contains another Sub-Menu. Press ENTER key to enter sub-menu and use ▲, ▼ keys to move between items. Leave Sub-Menu by pressing MENU key.</p> <p>In submenu Information it is possible to display one fixed message after another Data Logger Model, Data Logger Name, Serial number, Record mode (cyclic/non-cyclic), Memory occupation, Date and time in data logger, Language .</p>
--	---

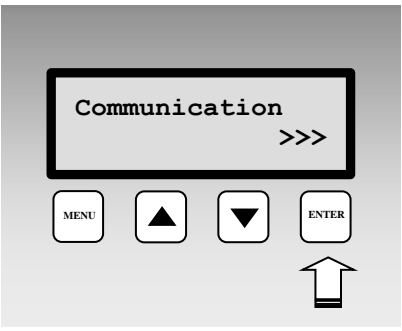
	<p>Menu item Communication</p> <p>Submenu Communication – enables to display and change Setting of communication interface, Communication speed, Data logger address in the RS485 network, data logger IP address, Gate IP address and Net Mask. Displayed items in menu depends on actually adjusted communication interface and optionally on implemented HW.</p> <p><i>Change of configuration can be selectable protected by PIN code, entered by the user. Way of entering PIN code is specified in Application notes.</i></p>
---	--

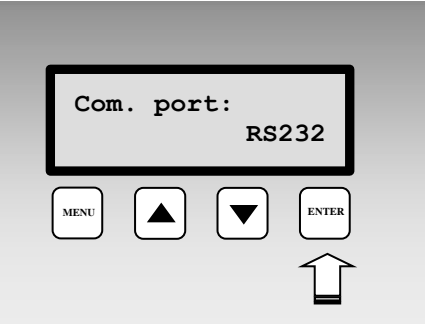
<p>Change of data logger communication interface</p> <p>Press ENTER key to enter selection of communication interface. Use ▲, ▼ keys to select required communication interface and press ENTER key to confirm the selection. Adjusted communication interface must correspond with physical connection and with SW configuration. If you choose selection Ethernet-DHCP, IP address is set and gate address to 0.0.0.0, network mask is set to Default (0).</p>	
---	--

Change of data logger communication speed

Press ENTER key to enter selection of communication speed. Use ▲, ▼ keys to select required communication speed and press ENTER key to confirm the selection. This selection is not available for Ethernet.

ATTENTION – standard computer COM port does not support communication speed 230 400 Bd. If data logger supports such speed, then it can be used in USB connection.

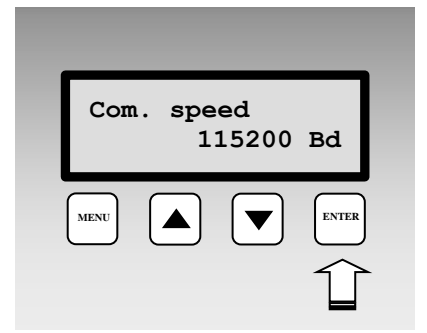

Change of data logger RS485 address

Press ENTER key to enter address selection. By means of ▲, ▼ keys select new address and press ENTER key to confirm selection. This selection is available only for active RS485 interface.

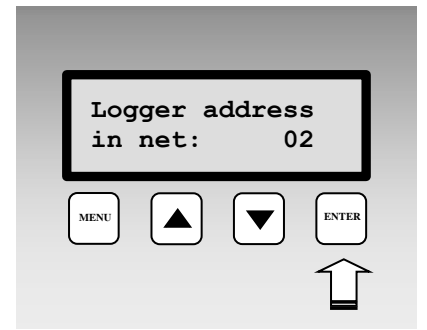

Change of data logger IP address

Press ENTER key to enter selection of data logger IP address. First position blinks. Select desired digit by means of arrow keys ▲, ▼. Press ENTER to go to next position. After editing the last position new data logger address is stored. This selection is available only for active Ethernet interface. Be careful in IP address setting. Incorrectly set address can cause network conflict or other complications. Always consult IP address setting with network administrator.

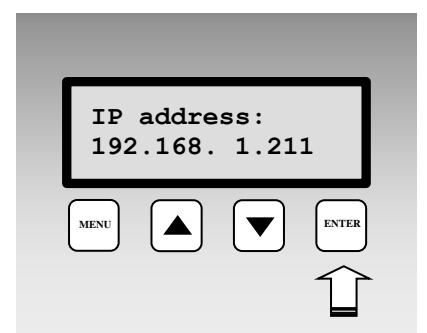

Change of gate IP address

Setting is analogical as for IP address. This selection is available only for active Ethernet interface.

Be careful in gate IP address setting. Incorrectly set gate address can cause network conflict or other complications. Always consult IP address setting with network administrator.

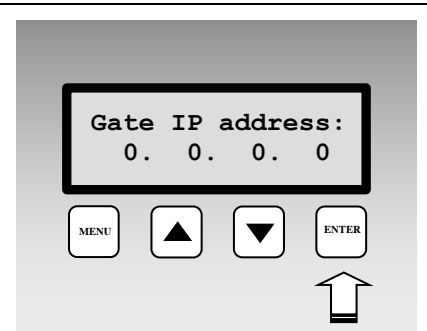

Change of network mask

Press ENTER key to enter selection of network mask. Select desired network mask by means of arrow keys ▲, ▼. Press ENTER to store mask to data logger. Network mask 255.255.255.255 is displayed as Default. This selection is available only for active Ethernet interface.

Be careful in network mask setting. If not necessary, do not change Default value. Incorrectly set network mask can cause data logger inaccessibility. Always consult network mask setting with network administrator.



Acoustic sign.
&ALARM OUT >>>



Menu item Acoustic signalization & ALARM OUT

Submenu for switch OFF the audio indication. This item appears **only, if user allowed in Common parameters Alarm Confirmation via menu.**

After entering actual states of audio indication and ALARM OUT output are displayed. If in active state, it is possible to deactivate by pressing ENTER key. New activation can be caused by creation of new alarm or by ending of alarm and new alarm creation, which caused this action. In case password requirement function is activated in SW, it is necessary to enter password first. *Way of entering PIN code and other options are specified in [Application notes](#).*

Service >>>



Menu item Service

Submenu enabling to display value of some Service parameters of data logger.

Service – display of self test of internal voltages

Self test of data logger internal voltage. First value indicates approximate power voltage (9 to 30 V, see technical parameters). Second value is voltage of negative source (-2V to -6V) and third value is voltage of internal back-up battery (2,6V to 3,3 V).

Selftest:
24V -5V 3.0V

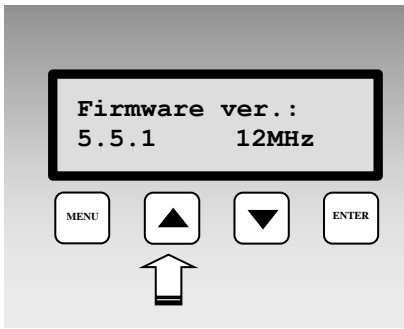

<p>Service – display of firmware version and uP speed</p>	
--	--

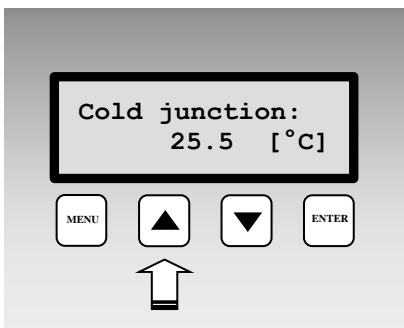
<p>Service – display of cold junction temperature of thermocouple</p>	
--	--

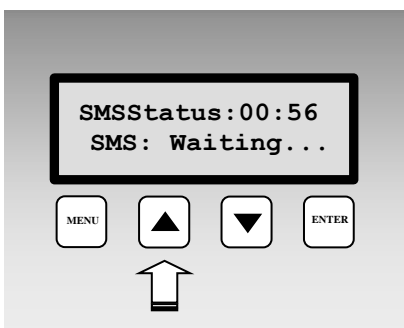
<p>Service – display of state of processing SMS Actual state of communication with GSM modem is displayed on the LCD. Press ENTER key to enter directly the display of receiving and sending SMS buffer.</p>	
--	---

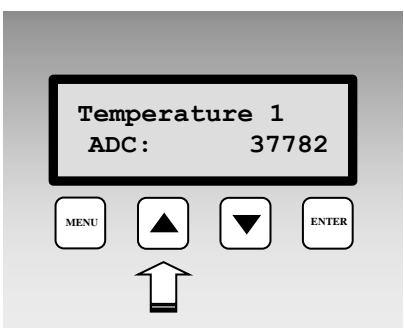
<p>Service – display of A/D converter values for measured channels Value read from A/D converter of analog inputs at range 0 to 65535. Limit value 0 indicates converter lower limitation (corresponds to Error1) and value 65535 (corresponds to Error 2) indicates converter upper limitation. With counter inputs binary state of counter is displayed. With binary inputs state of input (ON/OFF) is displayed and with RS485 input symbols „---“ are displayed.</p>	
--	--

5. USER PROGRAM FOR DATA LOGGER

The following text describes especially possibilities of data logger setting and some procedures of work with data. More detailed information on the program is in *Program Help*.

5.1. Program features

Software for data logger enables to configure data logger and process measured data. It can be download freely from www.cometsystem.com. After installation program can run in two modes as:

- **basic (unregistered) version** – enables configuration of data loggers and table processing of data. It does not enable graphic processing of data, automatic data download, storing of data outside of local computer, www display etc.
- **optional (registered) version** – after entering of purchased registration key optional functions of the SW are enabled. Entering of key is enabled in installation of the SW or anytime later.

Hardware and software requirements:

- the Windows 7 and later or the Windows Server 2008 R2 and later operating system
- 1.4 GHz processor
- RAM 1 GB

5.2. Installation of program

Run downloaded installation utility for MS data loggers. Installation wizard appears to perform all installation. Run installed program from menu Start-Program files-CometLoggers-MSPlus (if you did not change its location during installation).

For other USB devices, e.g. ELO214, installation of proper drivers to these devices is necessary.

5.3. Setting of communication with data logger

User SW enables to work simultaneously with several data loggers connected in different ways to the computer. Settings is performed in two steps:

- Selection of communication interface of the computer
- Data logger assigning to selected communication interface

You can find description of individual settings in the **Appendix No. 4**.

*If SW installation was just completed and the window Setting of communication is empty, then with data logger connected via RS232 and USB steps described below must not be performed. Connect data logger to the computer (wait with USB for awhile to let the system detect connected device and activate virtual COM port driver). **Then** run user SW and try to read data logger configuration (icon **i**). Computer searches all available COM ports and speeds and tries to find data logger. If this procedure fails or different interface is required or there are more than one data logger, follow below instructions. Optionally see detailed description in **Appendix No. 4**.*



Configuration in data logger must correspond with setting in computer. E.g. If data logger is set to RS232 interface and in SW Ethernet is used, data logger is not able to communicate.

If SW services several data loggers at the same time, you will be asked to choose data logger from the list before each communication with data logger. In the mode Display all data loggers are displayed in parallel (with the exception of those connected via modem).

5.4. Basic items in menu program

Item menu **File**:

- reading stored file from disk to the program and display data in to the table.
*Data in files are stored on disk in a special binary format, which is not compatible with standard formats. In case, value in table is not available or is not correct, error message is displayed – more information see in **Appendix No. 8***
- reading data from data logger
After this selection window for selection of data logger is displayed (if there are more than one), user can select name of file, where data will be stored and after if data logger will be erased after data transfer
- configuration of the printer
- configuration of program Options – *only in optional version of program*
- configuration of language localization
- logout of user – *only in optional version of program*

Item menu **Show**:

- table – *displays measured values, can be set different numbers of channels. Exports to dbf and xls format are available*
- graph – *only in optional version of program*
- Event viewer – *here actions are stored run by the SW with data logger and theirs result*

Item menu **Configuration**:

- Data logger settings – *detailed description will follow*
- Erase data logger memory – *after confirmation erasing is performed*
- Reset counter inputs and erase memory - *after this selection counter in counter modules (CTU, CTK) are reset and consequently data logger data memory is erased totally.*
- Reading configuration from file – *reads configuration from already downloaded file with data record. Configuration can be stored back to data logger or to the file.*
- Deactivate alarm signalisation – *if it's enabled, it is possible to cancel activity of ALARM OUT output remotely from the PC.*
- Communication settings – *you can find configuration description in the **Appendix no. 4**.*

Item of menu **Display** - *online visualization of measured values on the computer, reading interval can be set in section File-Options, bookmark Display (in basic version it is fixed to 10s, in optional version can be set from 10 s). In suitable configuration the mode can be shared on several computers. See [Application notes](#).*

6. DESCRIPTION of CONFIGURATION and DATA LOGGER MODES

Use menu item *Configuration – Datalogger configuration* to configure data logger parameters. After reading of configuration window is displayed with several bookmarks.



When changing configuration of data logger, all recorded data erasing can be required by the SW.

6.1. Bookmark *Common*

- enter data logger **name** – maximum length is 16 characters, use letters (no diacritic marks), digits, underline.
A folder under this name is created in computer, to store downloaded files with recorded data in. Data logger name is displayed on the display after switch on and is available in data logger Menu. The name is used for identification in user SW.
- check if **Date and time** in data logger is set correctly
- **Security**
 - if you need to define names and rights users of the system including protection of communication, then switch on *Datalogger security On/Off* and define each system user.
 - if you need to assign PIN codes to users for their identification in canceling of alarm signalization or optionally other rights, do it in window *User account – Details* (available due to *Users and password* button and option *Properties*) and switch on *Alarm confirmation by PIN1* and create new PIN code. If using system of security with PIN, always will be required PIN code after *Confirmation of alarm signalization* and *Condition setting from PC*.
 - if you need to secure some menu items of data logger against arbitrary overwriting, tick proper selection and enter PIN2. *This PIN2 is different from users PIN.*



If you use Users and password and forget the User name or password, then it is not possible to recover the communication in simple way!

- if you will need to mark parts of record with your notes during operation from data logger keyboard, use **Processes**. More detailed description is specified in chapter [Application notes](#).
- if you will use alarm output **ALARM OUT**, define, if and how data logger user can cancel its activity. *If you need to identify person, alarm was cancelled by, proceed in accordance with chapter [Application notes](#).*

6.2. Bookmark *Communication*

Here you can set:

- **Data logger communication interface** - you can change the type of used data logger communication interface



*Change of communication interface can cause after storing data logger configuration you would have to physically connect via this interface and change data in *Communication setting*. The change of communication interface and communication parameters setting can be performed directly from data logger keyboard.*

- **Baud-rate** – preset value is 115 200 Bd. If you use classic connection via RS232 (COM port), then this is the highest available speed. For USB connection you can use higher speed (in case it is supported by data logger). For Ethernet interface cannot be changes. For RS485 with larger networks a need to decrease the speed can appear.

- **RS485 network address** – relevant in communication via RS485, each data logger in the network must have different address!
- **Data logger responds to incoming SMS messages** – if data logger is connected to GSM modem, you can get actual measured values and alarm states by sending SMS from mobile telephone to number of modem. Data logger reacts on this text of received SMS messages: **Info, Alarm, Ch1 to Ch16, Set1 to Set16, Clr1 to Clr16**. For more details see chapter [Application notes](#).
- **Data logger sends SMS message when selected alarms are activated** – if data logger is connected to GSM modem, you can assign one to four telephone numbers to each alarm states warning SMS message containing description of created alarm is sent to.
- **Datalogger sends scheduled SMS** - if data logger is connected to GSM modem, then it can send scheduled SMS messages (information that system works correctly) to the selected phone numbers at specified hour and days per week. This feature is available for FW version 5.6.0 and later.

Quick and reliable SMS message delivery depends on quality of GSM network. Data logger has no information on credit on the SIM card. Use suitable tariff.

Features and settings of data logger Ethernet interface:

If data logger has installed and enabled Ethernet interface, then functions of this interface can be set at the right part of the window. Always contact your network administrator with setting of IP address, gate address and subnet mask to get correct values. Be very careful in network settings. Incorrect adjustment can cause data logger inaccessibility, conflict in network or other complications.

It is possible to set:

IP address of data logger – it must be unique address in your network, assigned by your network administrator (if you use DHCP, tick this selection, address then will be presented as 0.0.0.0.)

IP address of gateway – address of gateway or router, providing communication with other LAN segments. Address of gateway must be at the same network segment as data logger.

Mask of subnetwork – defines range of possible IP addresses in local network, e.g. 255.255.255.0

Size of MTU – size of packets, default is 1400 bytes. It is possible to lower it with some networks.

Sending of warning e-mails - if ticked, warning e-mails will be sent to below specified addresses

Sending of traps - if ticked, warning SNMP traps will be sent to below specified addresses

SysLog - if ticked, warning messages will be sent to below address of SysLog server

Web enabled – if ticked, www pages of data logger will be available

SOAP – if ticked, actual measured values will be sent to below address of SOAP server (in mode „Display“)

Bookmark Email (1):

IP address of SMTP server - If needed to send e-mails by the data logger, it is necessary to set correctly the address. Administrator of your network or your internet provider gives you the value of the address.

SMTP authentication - Setting of user name and password for login to server sending e-mails.

Bookmark Email (2):

Recipient of e-mails 1-3 - e-mail addresses of recipients. E-mails will be sent to those addresses in case of selected alarms

Sender - enables to set addresses of the e-mail sender. Selection Original sender sets sender name to <data logger name>@IP address

Send testing e-mail - sends testing e-mails to selected addresses

Bookmark SNMP:

Recipient of trap 1 – 3: IP addresses of recipients of SNMP traps.
Password for reading - setting of password for access to SNMP MIB tables.
Send testing trap - sends testing trap of 6/0 type to specified IP addresses.

Bookmark Web

Refresh - refresh time of automatic pages reading (update of displayed measured values). Range 10-65535 s.

Port – TCP port, built-in WEB server will be receiving queries. Default value is 80.

Bookmark Syslog

IP address of SysLog server 1-3 – IP address of servers, messages are sent to.

Send test message – sends test Syslog message to specified servers

Bookmark SOAP

IP address of SOAP server – IP address of server, on-line measured values, messages with data logger and alarms state are sent to (similar to the „Display“ mode)

Target web page – name of pages, where server has running script for incoming message processing

Source port – port number, data logger sends SOAP message from. Default set to 8080

Target port – port of server, where SOAP message is expected

Sending interval – how often data logger sends data to server

6.3. Bookmark *Profile*

- ***Cyclic record*** – if it is not ticked, then after fulfilling of memory data record ends. Measurement and evaluation of alarms continues. If it is ticked, then after fulfilling of memory oldest data are overwriting with newest.
- ***Alternative record times*** – record must not run in fixed time intervals, but it is enabled also to define up to four times in day, when measured values will be stored.
- ***Language*** – language localization of fixed messages on data logger LCD. It does not concerns language localization of program
- ***Alarm signalization*** – alarms can also be signalized acoustically or by ALARM OUT output. Signalization of alarm can be deactivated (cancelled) by the user, if it is enabled. It can be done in several ways:
 - by pressing of the ENTER key on data logger
 - by means of data logger menu with possibility to require PIN of user
 - remotely from the computer

In case alarm which activated the indication is cancelled and appears again, indication is activated again. Canceling (deactivation) of indication simultaneously refers to internal audible indication and to ALARM OUT output. For newer FW versions other options are available – see [Application notes](#).

- if there is a need to indicate acoustically some alarms directly in data logger, tick *Internal acoustic alarm signalization* and specify for each alarm, if alarm is indicated this way.
- If there is a need to activate ALARM OUT output, tick ALARM OUT and specify for each alarm, if alarm is indicated this way.
- changes of ALARM OUT output state can be recorded and it is enabled consequently to identify the user canceling the alarm by means of *Administration of users and passwords*.
- if there is a need to record changes of all alarm states, tick selection ***Recording of ALARM OUT state changes*** and ***Recording of all alarms changes***
- if there is a need to indicate acoustically the state of memory occupation, tick this selection
- ***SMS phone number list*** – if you use sending of SMS messages after alarm creation, then enter here telephone numbers for sending messages. *Enter numbers in international format with country code, e.g. 0049... or +49....*

- **Critical states actions** – it is enabled to assign actions similar to alarms to some error states, evaluated by data logger (error of measurement on some of input channels, error in configuration of data logger, reaching of specified occupation of data memory and self test error). Do not use zero duration time of critical state for evaluation of the action. Use at least 10s delay. If this state lasts this time without interruption, selected actions will be performed.

6.4. Bookmark *Ch.. Identity & Calculations*

This and the following bookmark refer to data logger input channels to be switched over in left lower window corner.

Set your own identification of measured points and optional conversion of measured values at this bookmark:

- **Type of input channel** – here select type and range of input channel. It is possible to choose from actually installed input module or from RP input module on different channel or *Interchannel recalculation*. *Interchannel recalculation* is specific type of input channel. By means of it is possible to acquire values as sum, difference or other combination of measured values from two another input channels:

$$MV = A * MV_j + B * MV_k + C$$

$$MV = A * MV_j * MV_k + C$$

$$MV = A * MV_j / MV_k + C$$

where MV are measured values, *j,k* are source channels

- in upper part of bookmark name and range of installed input module is specified for information.
- **Channel name:** - enter name of measured points in length of maximum 16 characters.
- **Physical unit** (except binary inputs) – you can select from the list or write your own in length of maximum 6 characters
- **Description of state open/closed** (in binary inputs) – user selectable strings in length 16 of characters to describe state „closed“/ „open“ resp. „without voltage“/ „with voltage“
- **Number of decimal places** (except binary inputs) – you can set maximum 5 digits behind decimal point.
- **Recalculation** (except binary inputs)- measured value from input can be recomputed by means of two-point linear transformation to other value. Default state is set to conversion 1:1 and full scale points of module input range module or value 0-0, 1-1 are used. Value can be arbitrary with the exception of state, both input values are the same.

Example: data logger with current input 4 - 20 mA is connected to temperature transducer with current output, which generates at temperature -30°C output current 4 mA and at temperature 80°C current 20 mA. Enter following values to the table:

Measured value 4.000 [mA] will be shown as -30.0 [°C].
Measured value 20.000 [mA] will be shown as 80.0 [°C].

- **Processes** (except binary inputs) – allow which processes are enabled to use. See [Application notes](#).
- **Address of connected device, Maximum waiting** etc. – setting of RS485 input, for more information see [Appendix No. 3](#).

6.5. Bookmark *Ch.. Measuring & recording*

- tick **Input channel is measuring and fires alarms** to enable this channel for measuring,

- if there is a need record measured value, select one from three available record mode. These modes can be combined. *Binary inputs enable only the third mode – record of state changes on input.*

A) **Continuous record** - if there is a need to record measured value to the instrument memory without respecting any other conditions, use this selection and select suitable logging interval. Logging function can be limited in time both globally (i.e. Date and time from ...to) and daily (daily from...to).
If no from offered logging intervals suit you, use record in alternative daily times, defined before on bookmark Profile.

Example of table with continuous record:

Date and time	Channel 1: T[°C]
1.1.2009 08:00:00	23,8
1.1.2009 08:30:00	24,5
1.1.2009 09:00:00	26,8
1.1.2009 09:30:00	33,2
1.1.2009 10:00:00	37,5
1.1.2009 10:30:00	42,3
1.1.2009 11:00:00	45,1
1.1.2009 11:30:00	45,2
1.1.2009 12:00:00	44,1
1.1.2009 12:30:00	40,1
1.1.2009 13:00:00	35,2
1.1.2009 13:30:00	30,1

B) **Conditional record**– if there is need to record measured value to the instrument memory only in case, if defined conditions are valid, then use this selection. Select suitable logging interval and assign conditions for the record. Logging function can be limited in time both globally (i.e. Date and time from ...to) and daily (daily from...to).
If no from offered logging intervals suit you, use record in alternative daily times, defined before on bookmark Profile.

Example of measured values list (condition for record – temperature is higher than 40°C):

Date and time	Channel 10: T[°C]
1.1.2009 10:55:00	40,1
1.1.2009 11:00:00	41,3
1.1.2009 11:05:00	40,2
1.1.2009 11:30:00	40,3
1.1.2009 11:35:00	42,5
1.1.2009 11:40:00	40,1

By means of continuous and conditional record situation can be solved, when device operation is monitored. In case of its trouble-free operation record with long logging interval is sufficient, but in case of failure there is a need to have detailed record with failure.

Example of list of measured values (continuous record with interval 30 minutes and conditional record with interval 5 minutes at temperature higher than 40°C):

Date and time	Channel 1: T[°C]	
1.1.2009 08:00:00	23,8	continuous
1.1.2009 08:30:00	24,5	continuous
1.1.2009 09:00:00	26,8	continuous
1.1.2009 09:30:00	33,2	continuous
1.1.2009 10:00:00	37,5	continuous
1.1.2009 10:30:00	39,3	continuous
1.1.2009 10:55:00	40,1	conditional
1.1.2009 11:00:00	41,3	continuous +conditional
1.1.2009 11:05:00	40,2	conditional
1.1.2009 11:30:00	40,3	continuous +conditional
1.1.2009 11:35:00	42,5	conditional
1.1.2009 11:40:00	40,1	conditional
1.1.2009 12:00:00	34,1	continuous
1.1.2009 12:30:00	30,1	continuous
1.1.2009 13:00:00	25,2	continuous
1.1.2009 13:30:00	20,1	continuous

Conditional record can be linked to a simple *Condition* or on logical *Combination of conditions* (maximum four conditions from different channels linked by operators AND and OR).

Example of conditional record in case of logical combination of conditions:

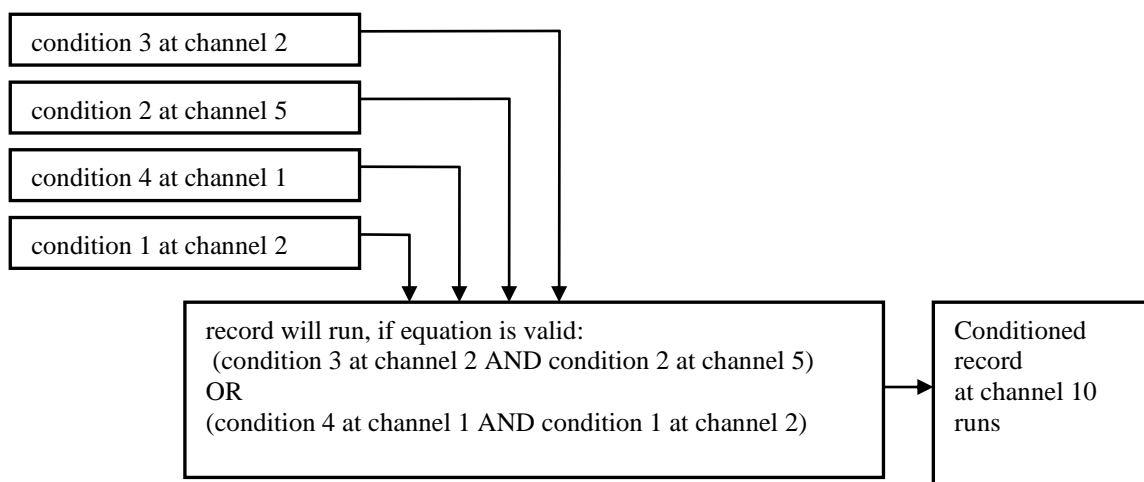

- C) **Sampled record** - if there is a need to know time and measured value when certain event appeared defined by *Condition* or *Combination of conditions*, use this selection. Work with conditions is similar as in previous case. Always time and value is stored when defined state of conditions started or was terminated.

Example table with sampled record:

Date and time	Channel 1: T[°C]
1.1.2009 08:01:11	23,8
1.1.2009 08:40:23	24,5
1.1.2009 09:05:07	26,8
1.1.2009 09:12:44	33,2
1.1.2009 10:08:09	37,5
1.1.2009 10:32:48	42,3

Record of binary channels behaves analogically as sampled record, when each change on binary inputs is stored. Value is replaced by text description, which corresponds with user configuration.

6.6. Bookmark *Ch..Conditions*

Condition defines certain state of measured value (exceeding of adjusted limit upwards/downwards, defined state of binary input) on specified input channel. It can have two states: valid-invalid. Up to four independent conditions at one channel can be defined. Creation of alarm states depends on state of conditions and sampled and conditional record can be controlled by them:

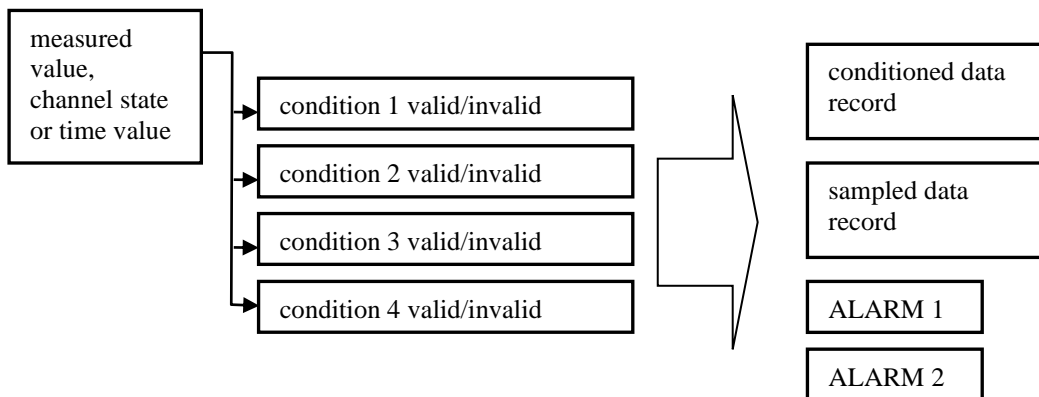

Data logger enables to set condition depending on measured value, on time and condition, which validity is remotely controlled. Each from four conditions it is possible to switch on for evaluation. Binary inputs has lower number of possibilities to set conditions, setting is analogical.

A) If there is a need to activate some actions dependent on **Measured value**, select *Start of validity: Input value*

Example:

Select, if condition will be valid, if measured (*Input*) value is higher or lower than adjusted limit (170) and how long must this state last without interruption. Than condition becomes valid (30s, maximum 65535s). Define further circumstances for termination of condition validity. If no validity termination is defined, condition remains permanently valid (till change of data logger configuration). You can select validity termination after value return back with hysteresis (2) OR (optionally AND) if defined time expired (maximum 65535 s).

You can also define, how the state of the condition works if measurement error appears:



If other devices are controlled based on validity of the condition (relay outputs, sending of SMS message, audible indication etc.), always use nonzero hysteresis and nonzero time delay for creation of condition validity to avoid false alarms at transient effects of input value.

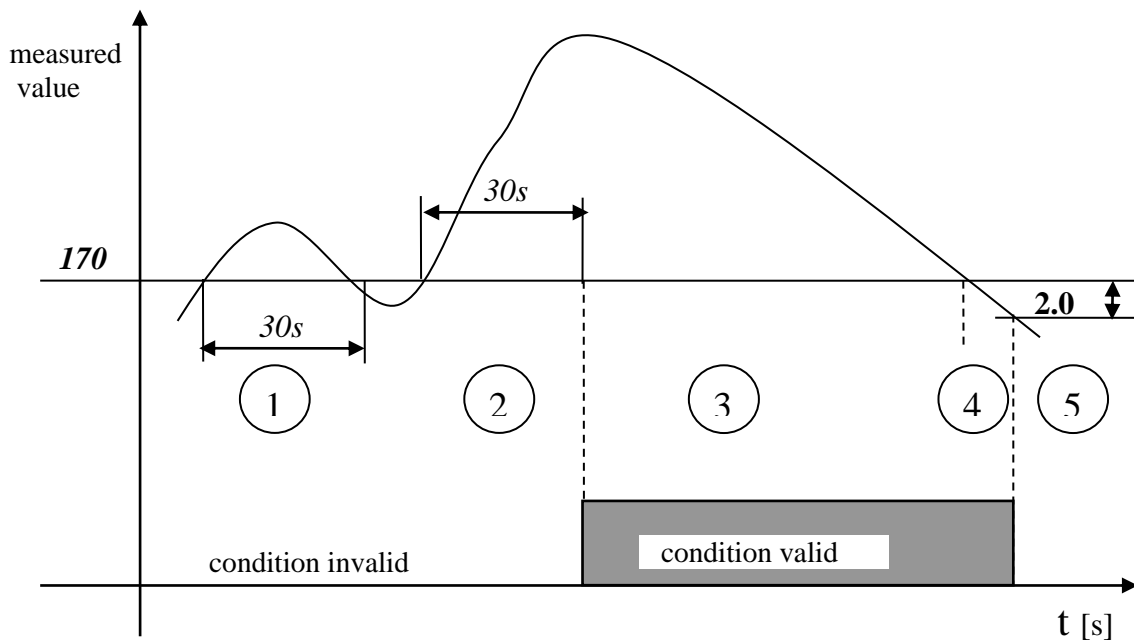

Description of function:

Area 1... measured value exceeded limit, but was not over this limit for required duration, condition invalid.

Area 2 ... measured value exceeded limit and was over this limit for required duration. After finishing adjusted condition became valid.

Area 3 ... measured value is still over limit, condition is valid

Area 4 ... measured value already dropped below limit, but nonzero hysteresis is adjusted, for finishing of condition validity measured value must drop of adjusted hysteresis value

Area 5 ... measured value dropped below limit decreased of hysteresis, condition is invalid

Switching of data logger power in different condition states:

1. if power of data logger is switched OFF in area 2, after switching ON measured value is still over limit and required delay is not over, data logger continues in testing on, as no power failure would appear.
2. if power of data logger is switched OFF in area 2, after switching ON measured value is still over limit and required delay is over already, condition becomes valid immediately
3. if power of data logger is switched OFF in area 2 and after switching ON measured value is not over limit, cycle of time testing is interrupted (similarly as in area 1).
4. if power of data logger is switched OFF in area 3 or 4, after switching ON measured value is over limit decreased of hysteresis, condition stays valid. But if measured value does not match this, condition is invalid immediately.

Other examples of configuration of conditions depended on measured value:

- *Setting of condition validity at measured value drop:*

Condition 1

Start of validity: < °C for the duration of s

End of validity: value returns back with hysteresis °C expires s

In the case of input error (measured value is not available):

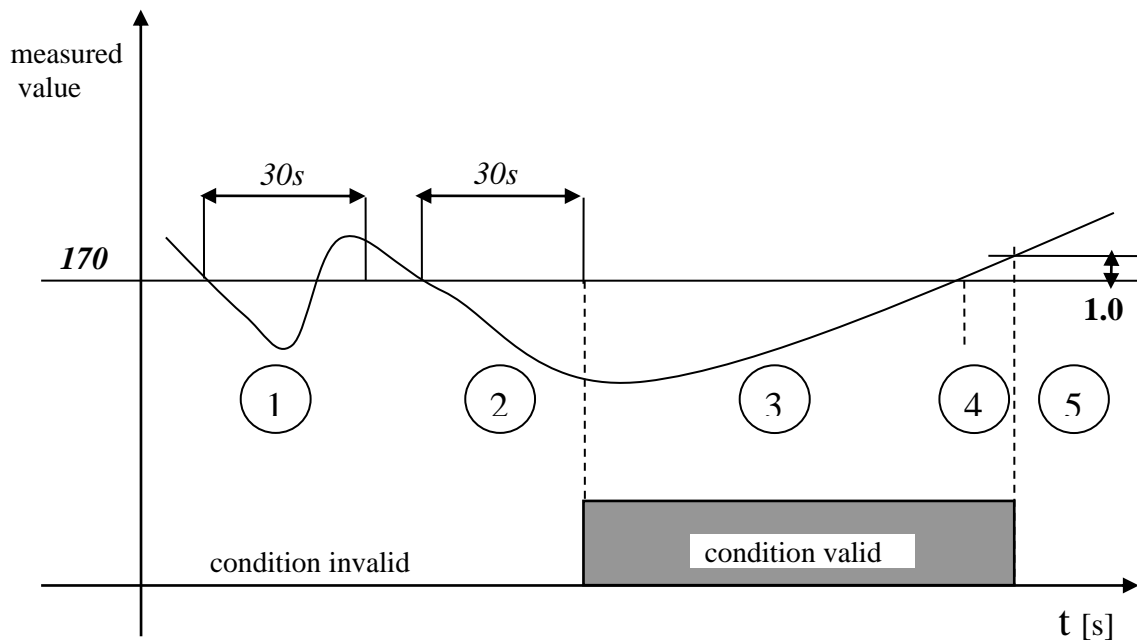

- *Condition with fixed specified time validity*

Condition 1

Start of validity: > °C for the duration of s

End of validity: °C expires s

In the case of input error (measured value is not available):

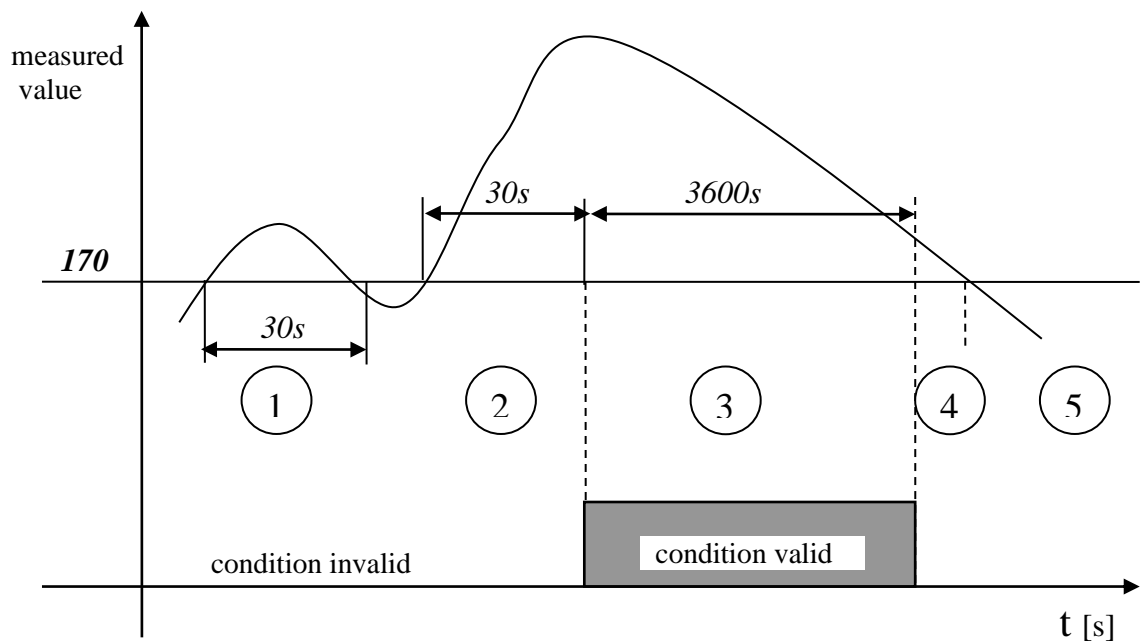

To renew validity of condition measured value first must drop below specified limit and then to exceed the limit.

- *Combination of condition validity termination with hysteresis OR after specified delay*

Condition 1

Start of validity: > °C for the duration of s

End of validity: value returns back with hysteresis °C or expires s

In the case of input error (measured value is not available):

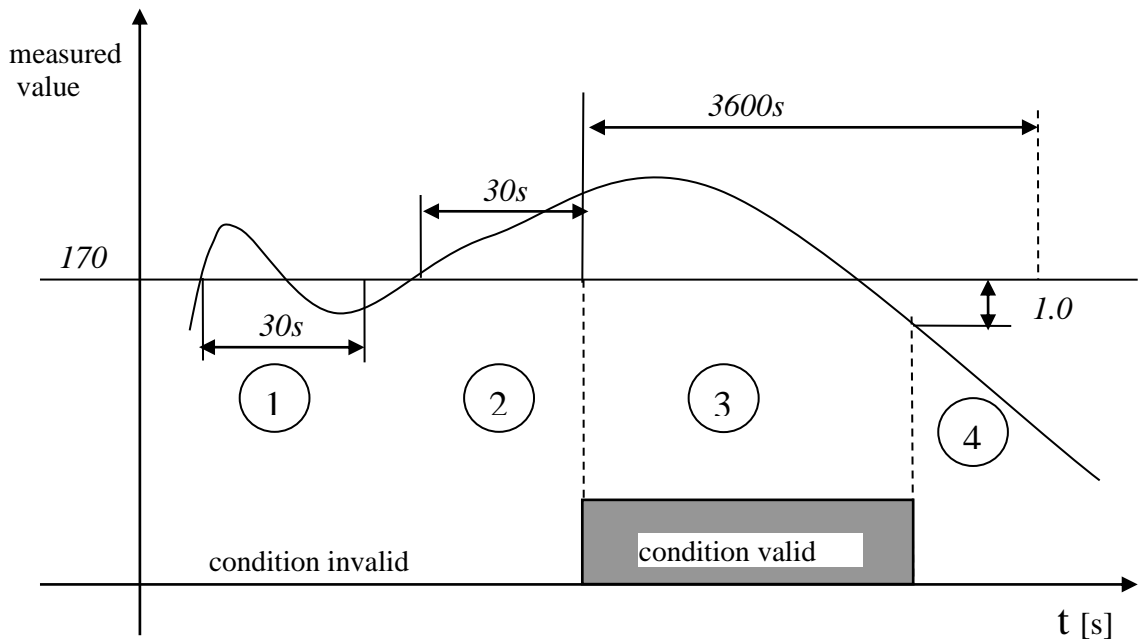
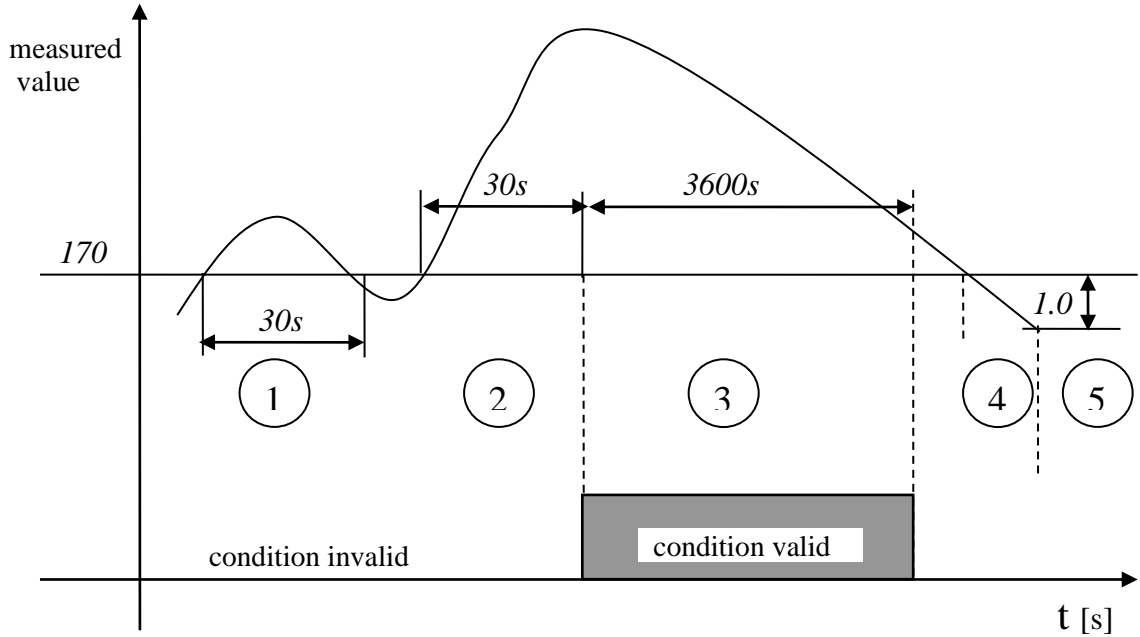

To renew validity of condition measured value first must drop below specified limit and then exceed the limit.

Combination of condition validity termination with hysteresis AND after specified delay

Condition 1

Start of validity: > °C for the duration of s

End of validity: value returns back with hysteresis °C together with expires s

In the case of input error (measured value is not available):

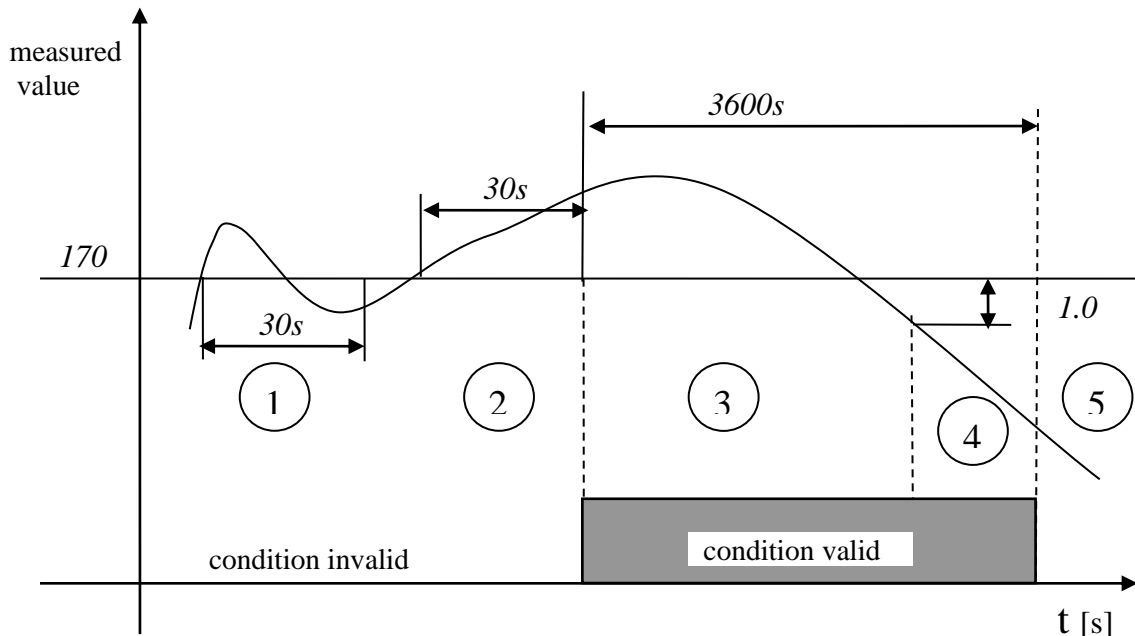

- B) if there is a need to control validity of condition only by date, time and day in the week, use selection **Valid in time interval**

Example:

Condition 1

Start of validity:

valid daily in time interval

from to

valid only in interval

from to

valid on selected days:

Monday Friday Saturday Sunday

Tuesday Wednesday Thursday

- C) if there is a need to control validity of condition directly from computer, use selection **Set remotely from PC**. In this case authorized access by user PIN code entering is enabled (if using *Administration of users and passwords*). If condition number 4 is set this way on any input channel, condition can be controlled also by means of SMS messages.

Example:

Condition 1

Start of validity:

6.7. Bookmark *Ch..Alarms and indication*

Two alarm states for each channel are enabled to define. Several actions are enabled to assign to each alarm. Alarms are defined based on validity of *Conditions* or based on logical *Combinations of conditions* (maximum four conditions from different channels).

Wiring diagram of possibility of alarm states creation and associated actions:

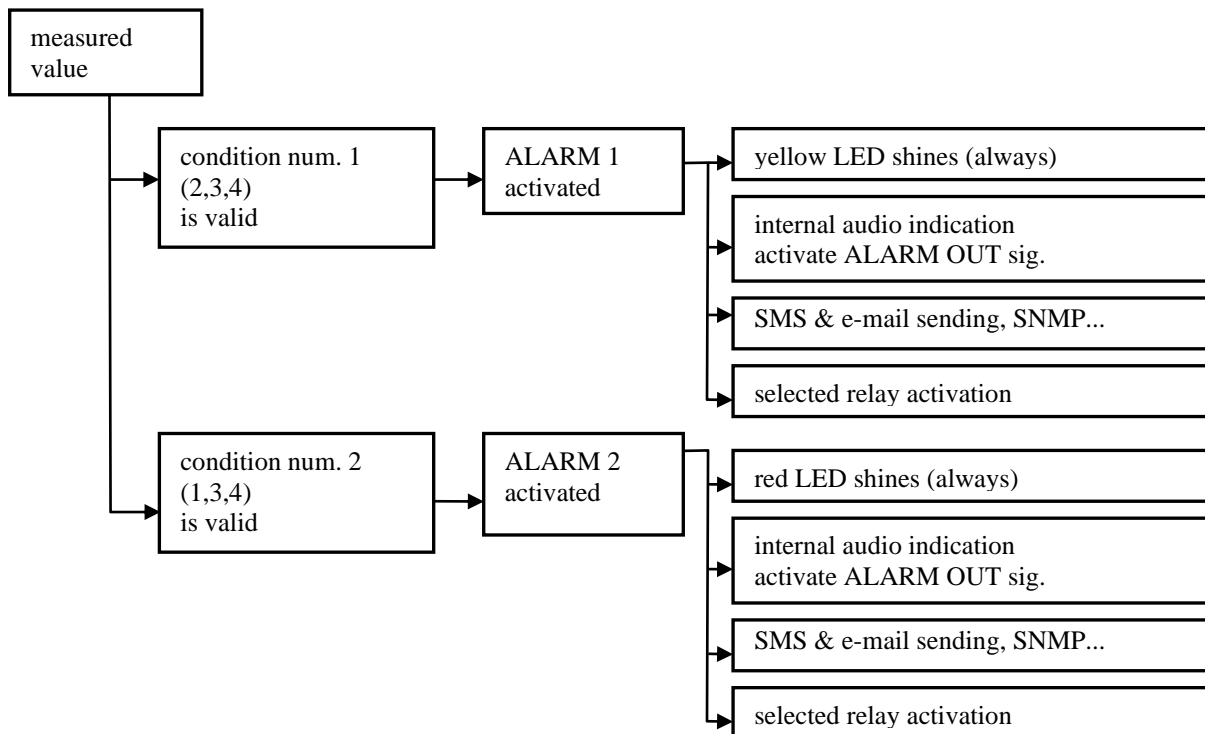

Example of alarm creation at used logical combination of conditions:

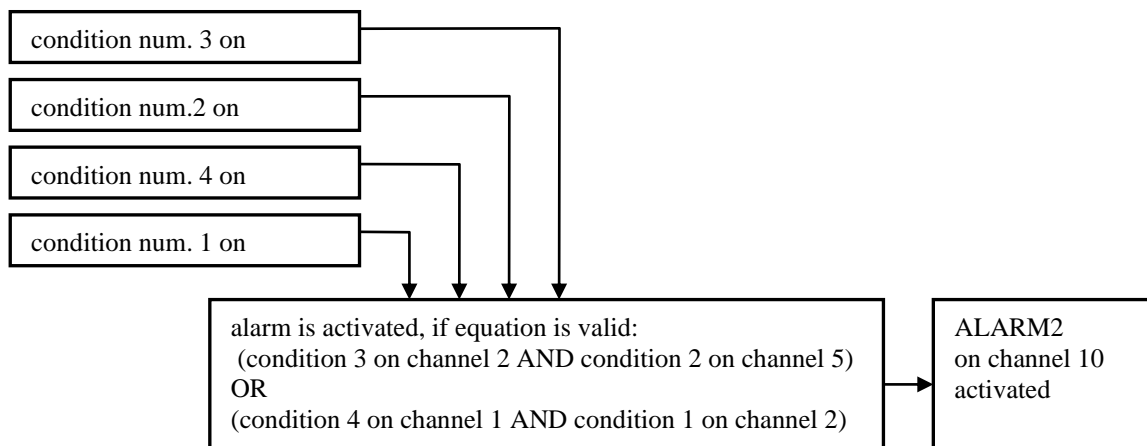

Alarm is active, if input conditions are valid. By means of combination of conditions you can solve also complex situations including remote control. Some actions last during all alarm time (audible indication, ALARM OUT output activity, visual indication, relay closing), other actions last only at the moment of alarm creation (SMS message, e-mails). Changes of ALARM OUT output state or all alarms state can be recorded.

7. APPLICATION NOTES

7.1. *Processes and how to work with*

Process is the name of action recorded by data logger in time. User of data logger can enter from its keyboard to each input channel (except binary inputs) different previously preset names of processes and such way to distinguish in record, which action was performed at that time. Example can be smoke-box for meat. During one working shift different products are processed consequently (names are known before and stored in data logger).

Way of work with processes:

- In configuration of data logger write to *Process label list* all processes (e.g. kind of products) meant for the data logger. Maximum processes is 16 and each process name can contain maximum 16 characters
- select for each channel, which processes will be used (all-some-no). This selection simplifies choosing process (kind of product), when only relevant processes will be offered for the channel.
- at the beginning of the process (e.g. after inserting one kind of product to the meat smoke-box) user finds the desired input channel and presses and holds ENTER key on the data logger keyboard. The name of the first process is displayed. By means of arrow keys preset name corresponding with the product can be selected. By pressing ENTER key again this process in data logger will be activated.
- when the operation is finished and user requires another process (e.g. another kind of product is inserted to the meat smoke-box), it is activated in similar way. Optionally no process is assigned.
- after recorded data download to the PC each time section of the record will be described with name of process, which was active in specified time
- by short pressing of ENTER key on data logger it is possible to display actually active process

Using of Processes is not possible with binary channels (S, SG, S1).

7.2. *SMS message and how to work with*

If data logger is connected to modem with support SMS function, it is possible enable the following action:

- response on incoming SMS queries, when following possibilities exist:
 - a) **Info** – if SMS is sent to modem with this text (both capital/lower-case letters are allowed), SMS response is received containing basic information on data logger (type, name, memory occupation, channel names, measured values and alarm states). This SMS can consist of up to four partial SMS messages depending on configuration of data logger. One long SMS can be displayed on mobile telephones with support of long SMS.
 - b) **Alarm** - if SMS is sent to modem with this text (both capital/lower-case letters are allowed), SMS response is received containing basic information on data logger (type, name) and channel numbers in active alarm states.
 - c) **Ch1** - if SMS is sent to modem with this text (both capital/lower-case letters are allowed), SMS response is received containing basic information on data logger (type, name), channel 1 name, actual measured value and alarm state at channel 1. For other channels enter corresponding number (e.g. Ch11 for channel 11).
 - d) **Set1** resp. **Clr1** – if SMS with this text is sent to modem (both capital/lower-case letters are allowed), then manual control of so called Remote condition by means of SMS messages is enabled. Command **set**<number of channel> activates condition number 4 on selected channel. Command **clr** < number of channel > deactivates this condition. Control of condition number 4 by means of

SMS can be performed on any channel. Condition must be set to Remote (Setting from PC). Answering SMS is received containing basic information on data logger (type, name) and actual status of set condition. In case security system with passwords is used, then PIN code will be required in manipulation with this condition. Insert space character behind command *Setn* then insert space character and corresponding PIN code (e.g. *Set8 1234*). In case of error (incorrect condition setting or incorrect PIN code) answer contains error message instead of status of set condition.

- sending of SMS with alarm report - in case alarm at one of input channels appears, data logger can activate modem and send SMS message. Up to four telephone numbers are enabled to enter to common parameters. It is possible to select for each alarm at each channel to which telephone number SMS message will be sent. If alarm state of measured value appears, data logger sends SMS in above format **Alarm**. If critical state in data logger appears, one SMS is sent with specification of data logger type, name and names of critical states (error of configuration, measurement, selftest or memory occupation limit).

ATTENTION – Data logger has no information on state of credit on SIM card. Use suitable tariff ensuring reliable SMS messaging.

More detailed information on support of SMS messages are in **Appendix No.9**.

7.3. Possibilities of setting Logging interval

Logging interval is for each record mode (continuous, conditional) and for each channel individually selectable. These intervals are available: 1s, 2s, 5s, 10s, 15s, 30s, 1min, 2min, 5min, 10min, 15min, 30min, 1h, 2h, 3h, 4h, 6h, 8h, 12h, 24h. Storing is performed always in whole number multiples of above intervals. E.g. *if data logger is switched on at 5:05 and the interval is set to 1 hour, first data are stored at 6:00, next at 7:00 etc.* Additionally to above logging intervals record is enabled also in alternative daily time. Maximum of four alternative logging times can be defined for entire data logger. For each channel is possible to select from them.

Note: *Data logger measure one channel after another. Measurement of one channel takes approximately 80 ms. It means if all 16 channels are active, the total measurement time is about 1.3s. This is important with shortest logging intervals.*

7.4. Identification of person, who deactivated alarm

- switch on administration of users and passwords
- define PIN code for each user in part *User account* and switch on *Alarm confirmation by PINI*
- check if option *Confirmation of alarm signalization by menu* is switched ON and option *by enter key* is switched OFF.

7.5. Way of entering PIN code from data logger keyboard

Data logger can work with two kinds of PIN codes:

- PIN1 codes related to particular user names and used to cancel alarm and for remote setting of conditions - maximum 16 PINs
- PIN2 code designed only for protection of data logger configuration against undesirable changes from data logger keyboard. This code is only one for all secured selections and has no relationship with *Administration of users and passwords*.

Way of entering PIN code:

- on data logger LCD is displayed requirement Enter PIN and four asterisks
- by means of arrow keys enter first (highest digit) and press Enter
- after entering the last digit and pressing button Enter validity of PIN code is checked. If valid editing of selected item is allowed

- if you make an error in entering code, press several time button Enter to get back to the beginning of entering PIN code and repeat the whole action

7.6. *Sharing of Display mode on several computers together with automatic storing of data on network*

- Optional SW version is required
- On the computer connected to data logger set in operation system After Start user program of MS monitoring system.
- Run program and in menu File – Options on bookmark Folder and data files enter path to server where data will be stored.
- At bookmark Display tick Run at program start and tick below Remote www access. Note specified computer name or IP address.
- At bookmark Automatic download select day and hour of data download, optionally other selections and confirm window.
- Check in menu Configuration- Communication settings, if automatic data download is allowed for data logger – "A" and "D" must be ticked next to data logger name (A as Active, D as autoDownload). If not, tick it (by box checking or due to *Edit* button).
- Restart the computer. A while after user MS program would run with Display mode.
- Go over another computer and in internet browser to the Address filed enter computer name you have noted before. You would see www pages with actual measured values.

If data logger is equipped with Ethernet interface, then www pages of data logger are accessible without the need user PC program is running.

7.7. *How to ensure alarm report, in case of power failure*

Data logger can be set in the way relay of ALARM OUT output will be closed in the state without alarm and will only open in the alarm state. Such inverse configuration can be set in advanced menu of the SW. Then it is sufficient to back up with batteries only suitable alarm dialer (e.g. telephone dialer) and state without power for data logger will correspond with alarm state, which causes alarm report to the user. Description of setting is specified in **Appendix No. 6**.

7.8. *Back-up of data logger configuration and its restoring*

If there is a need to back up data logger configuration to the computer and have the possibility to upload the configuration to the same or another data logger, read record from data logger. Stored file on disk contains among others also complete configuration of data logger. If you use selection in menu *Configuration – Reading configuration from file*, you can display this configuration and store to the connected data logger. If connected data logger has different serial number from numbers stored in file, this number and some other items related to particular board will not be overwritten. The rest of configuration is stored to the data logger.

7.9. *How to set variable condition limit according to measured value on other channel?*

Set up *Type of input channel* to *Interchannel recalculation* and assign another channels difference to it. Set condition limit to zero for this channel. This function reduced number of useabled channels by one.

7.10. *Can be confirmation of alarm signalization applied to acoustic alarm only?*

Yes, it is possible for MS55 data logger with firmware version 5.6.0 and later. The settings are possible at the Common bookmark - Confirmation of alarm signalization – button Advanced. Use the latest version of software.

7.11. *It is possible to force confirmation of alarm signalization again after some time?*

Yes, it is possible for MS55 data logger with firmware version 5.7.0 and later. The settings are possible at the Common bookmark - Confirmation of alarm signalization – button Advanced. You can set the time period after which the alarm signalization is activated again, even if alarms have not changed. Use the latest version of software.

7.12. What is it “latched alarms”?

If any alarm is appeared, it stays active regardless the measured values. This state persists until to the confirmation of alarm signalization when the alarms are set according to the actual measured values. This feature is available for MS55 data logger with firmware version 5.6.0 and later. Description of setting is specified in *Appendix No. 6*. Use the latest version of software.

7.13. Other possibilities in data logger configuration

Some settings are not accessible to usual users and are designed for qualified user. The work is described in Appendixes and special *Service manual*.

7.14. What to do if data logger does not work

- Does the LED diode light on power source (if there is any)? – if not then there is no mains voltage or the source is faulty or the fuse is broken (then the cause can be in data logger). Check connection of power to data logger. If the fuse breaks after source plug in mains disconnect all terminals and connectors except power from data logger and try again. If it works connect cables one after another and try to find the failure.
- Does the LED diode light on power source? - if not replace fuse in data logger. Use the same type!
- If the LCD display is off and data logger does not communicate probably qualified repair will be necessary.

7.15. Self test error

If self test is not OK, data logger after switching ON reports self test error with specification of incorrect voltage (power voltage, internal battery and negative source voltage). If error in Ucc, try to measure the power voltage on data logger. It is necessary to fix the failure. If sending of SMS message in selftest error is set, use suitable delay, e.g. 30 s.

7.16. Problems with correct measurement

- Data logger measures incorrectly at some inputs:
Disconnect all inputs and let connected always only one and watch values on data logger. If correct then problem can be in cabling or in input device (incorrect connection, undesirable loops).
Typical values on display when current loop is open (4 to 20) mA for several selected input ranges:

Assignment of input value for current 4 to 20 mA in user calibration	measured value by data logger if current loop is open
-30 to 60	-52,5 or Error1
-30 to 80	-57,5 or Error1
-50 to 30	-70,0 or Error1
0 to 150	-37,5 or Error1
0 to 100	-25,0 or Error1

Message Error2 with current loops indicates exceeding of current 20 mA

In case of measurement of resistance (e.g. sensors Pt100, Pt1000, Ni1000 and others) the following errors can appear:

Error1: short circuited sensor

Error2: broken sensor

Data logger time from time and totally irregularly indicates totally incorrect value:

Failure shows nonsensical value in record, on the display and short alarm activation. Most probably it is caused by electromagnetic interference. Effect is typical if correct rules for installation are not followed. It is necessary to check cabling, to change cable routing, to try to reduce interference etc. Most often this effect appears with current loops powered from data logger, which are connected to transducers of resistance sensor to current, if resistance sensor shielding is not connected properly or shielding is perforated to ground of other devices. Adjust suitable alarm delay t_{ON} (see setting conditions) in risky installations. Also faulty probe or transducer can cause such troubles.

7.17. Problems in communication with computer

*Possibilities of trouble shooting of usual problems can be found in **Appendix No. 4** at concrete communication interface.*

8. RECOMMENDATION FOR OPERATION AND MAINTENANCE

8.1.1 Operation of data logger in various applications

Before application it is necessary to consider if data logger is suitable for required purpose, adjust optimal configuration and create instructions for its periodical metrological and functional verifications.

Unsuitable and hazard applications: data logger is not design for applications, where failure of operation could cause endanger of health or function of other device supporting life functions. In applications, where failure of data logger could cause loss on property, it is recommended to amend system of independent indication device to monitor this state and avoid damages. It concerns especially control and indication outputs of data loggers. In critical applications it is suitable to power data logger from backed-up sources (UPS) dimensioned to required operation without mains power. Furthermore critical can be data logger connection to power itself. *It is not suitable to power both data logger and critical device – e.g. freezing box – to one fuse. If fuse is disconnected, then neither data logger nor monitored device is working. . In such applications it is useful to set inverse behavior of output ALARM OUT, when status without alarm is signaled by closed relay.*

Location of temperature transducers: locate them to places with sufficient airflow and where most critical point is supposed (in accordance with application requirements). Transducer must be located sufficiently inside of measured room or be connected to, to avoid thermal influence of leading wires to measured temperature. *In monitoring of temperature in air-conditioned room, do not locate transducer to direct flow of air conditioning unit. E.g. at large chamber refrigerators can be temperature profile very inhomogeneous, deviations can reach up to 10 °C.*

Location of humidity transducers: in measuring of humidity in refrigeration boxes without additional humidity stabilization, strong changes of humidity can occur in switching on/off the refrigeration (up to tens of % RH) even though mean RH value is stable.

Optimum data logger operation: it depends on particular application. Important is the setting of logging and alarm parameters. It is necessary to take into account the memory capacity of data logger and frequency of data transfer to the computer. Select logging mode depending on preferable way of data management. If newest data are preferred select cyclic mode, if oldest data are preferred, select noncyclic mode. Further more consider if data will be erased from data logger after data transfer to the computer. In case data will be erased, then a long-term record is not stored in one file and it is not possible to identify eventual failures. In case memory is not erased, then data transfer duration to computer can be a problem. If there are problems with data logger, it is recommended not to erase data. Alarm delay and hysteresis settings are very important.

8.1.2 Recommendation for metrological verification

Metrological verification is performed in accordance with application requirements specified by the user. One year the manufacturer recommends periodical verification.

Notice: *accuracy of data logger input means accuracy of input itself without probes.*

In verification of thermocouple inputs it is necessary to take into account that cold end compensation is perform inside of data logger, where temperature is mostly slightly higher than ambient temperature on the outer connector. Best way is verification together with connected thermocouple.

8.1.3 Recommendation for periodical verification

Manufacturer recommends periodical verification of the system yearly. Interval and range of verification depends on the application. In stationary installations following verification is recommended:

1. Metrological verification
2. Regular overhaul in intervals accordingly to corresponding standards
3. Evaluation of all problems from the last verification
4. Visual inspection of data logger
5. Functional verification of data logger (functions used in application):
 - A) verification of data transfer to computer
 - B) verification of alarms – change input value to activate alarm and check on display and also in external audio indication (if used)

- C) evaluate in data logger if relay contacts live
- D) evaluate internal battery – third value in self test must be at least 2.6 V
- 6. Verification of cabling – check the connection quality of cables, check visually entire cable length for damage and the route of cables for interference, especially whether some parallel power wires are not near.
- 7. Visual inspection of transducers for possible interference or water penetration.
Make a verification protocol.

8.1.4 Recommendation for service



Service of data logger is made at manufacturer or authorized partner. There is no service allowed without authorization from manufacturer. Unauthorized encroachment leads to loss of all warranty. *The most common damage due unauthorized manipulation with input modules is damage of the motherboard, when modules are connected in improper way.*

8.1.5 Placing out of operation after end of device life

Disconnect the power cord and return data logger to the supplier or specialized company. Notice: *data logger contains back-up Lithium battery on motherboard and on each counter input module (CTU, CTK)*

9. TECHNICAL DESCRIPTION AND PARAMETERS OF DATA LOGGER

9.1 Circuit concept of data logger

Data logger is designed as autonomous complex controlled by its own microprocessor, which fully works if power voltage is connected. If power voltage is not present, data logger does not work, but recorded data and internal time are saved.

9.2 Not allowed manipulation and warning



Power source is a device connected to electric mains and if it is damaged including power cord there is danger of injury by electric current. It is not allowed to connect it to mains, if power cord is damaged or if its cover is damaged or removed. It is also not allowed to place it in humid and dangerous environment (e.g. bathroom etc.), at points exposed to direct sun radiation and other thermal sources, to prevent damage and deformation of the case. Data logger should not be operated with not protected terminals if dangerous voltage is connected. Galvanic isolation is not designed for protection from electric current injury. In those cases it is necessary to apply additional isolation modules (e.g. measuring transformers). With this data logger operation of input modules with higher input voltage than is 50V AC / 75V DC is not allowed.

9.3 Technical parameters of data logger

9.3.1 Power

Data logger is powered from external ac/dc adapter or from other suitable DC source.

Power of data logger	
Power voltage:	24 V DC (24V±3V) ⁽²⁾
Maximum consumption:	25 W ⁽¹⁾
Recommended power source:	SYS1308-2424-W2E or ENCO NZ 21/25/1000
Protection:	tube fuse F2A on mother board

⁽¹⁾ It concerns maximum consumption with 16 inputs of A0 type with short circuited input terminals. These input modules contain source for powering of current loops of connected transmitters and are capable to supply to short circuit approximately 25 mA/input. With power 24V this additional power loss is approximately 10 W. For more details see Appendix 1.

⁽²⁾Detailed information on power voltage for data logger and current consumption is specified in Appendix No.1.

9.3.2 Output relay module for data logger

Module contains 16 mains relay with switching-over contacts connected to self-locking Wago terminal on the module. Each relay has three terminals available.

Maximum voltage on the contact:	250 V AC*
Maximum current through the contact:	8A
Maximum switching power:	2000 W
Mechanical life of relay contact:	3 x 10 ⁷ cycles
Electric life of relay contact:	1 x 10 ⁵ cycles
Material of contact:	Ag Cd O
Maximum wire cross section in terminal:	1,5 mm ²
Dimensions	140 x 211 mm
Mounting	MP019 on DIN rail 35mm or MP013 holders

*... Pay attention to all required safety rules in mounting and during operation!

9.3.3 Output ALARM OUT

This output is designed especially for connection of external audio indication or telephone dialer. Way its activation can be programmed in data logger configuration. Output is available both in voltage version and as galvanically isolated relay contact.

Parameters of output ALARM OUT in activation:	approximately 4.8 in DC, maximum 50 mA
Parameters of inactivated output:	0V, no load allowed
Connection:	terminal Wago
Length of connection cable:	maximum 100 m, only at indoor environment
Used relay	250 V AC/ 8A
Maximum connectable voltage on relay and current	24 V AC/ 1A

Galvanic isolation is not designed for safety function (not sufficient isolating distances). The case of external audio indication is designed for wall mounting and the connection is by means of connector CINCH (outer contact – GND, central pin – ALARM OUT).

9.3.4 Communication interface

Each data logger is equipped with interface RS232C, RS485 and USB. Ethernet interface is optional. Communication interfaces are mutually connected internally and as one functional unit galvanically isolated from other data logger circuitry. Communication with data logger is enabled only via one selected interface. Status of other interfaces does not effect this communication (it is set on the display of data logger v menu).

RS232C:	Used signals:	RxD, TxD, GND RTS-CTS selectable from SW
	Galvanic isolation:	electrical strength 500 V DC
	Connector:	DSub 9 male, signals DTR-DSR are connected
RS485:	Maximum cable length:	15 m, only in indoor environment
	Input impedance:	approximately 12 kΩ
	Galvanic isolation:	electrical strength 500 V DC
USB	Connection:	dual terminals
	Maximum cable length:	1200 m in indoor environment
	Compatibility:	USB1.1. and USB 2.0
	Connector:	USB type B
	Vendor ID:	0403
Ethernet	Product ID:	6001
	Compatibility:	10/100 MBit Ethernet, galvanic isolated
	Connector:	RJ45



Galvanic isolation is not designed for safety function - protection against electrical current injury!

the way of communication	
Setting of communication	serial link, 1 start bit, 8 data bits, 1 stop bit, without parity
communication speed	1200Bd ¹⁾ , 9600Bd, 19200Bd, 57600Bd, 115200 Bd, 230400Bd ²⁾

¹⁾... this speed is adjustable only for SMS messages transmission by means of interface RS232

²⁾... only for communication with the PC. If the speed is supported by data logger, it suitable for USB (COM ports of the computer generally does not support this speed).

Serial interface for reception and sending SMS message:

This interface serves for data logger communication with GSM modem for reception and sending of SMS messages. Interface is wired always to RS232 connector.

If data logger is set for communication with computer via other interface than RS232, then in case of enabled SMS messages support data logger communicates in 10s intervals with modem to evaluate state of received SMSs and sent alarm SMSs.

In case data logger is set to main interface RS232, then it is supposed, data logger has connected GSM modem to this interface. Interface is used both for SMS and for communication with computer. SMS messages evaluation is performed with the 2 minutes interval, but only in case, no communication with the PC is in progress. If communication with the PC is in progress, SMS interface waits until channel is free.

9.3.5 Data memory

Total memory capacity:	up to 480 000 analog values (count of binary values can be more)
------------------------	--

9.3.6 Real time clock circuitry

Contains actual data with seconds, minutes, hours, days, months and years. Circuitry works even if data logger is disconnected from power.

Error of time value:	maximum 255 ppm \pm 5 ppm/year at temperature 23°C \pm 10 °C
----------------------	--

9.3.7 Internal battery

Serves to back-up recorded data and to power of real time clock (RTC) in case, data logger is not connected to power.

Type of battery:	Lithium 3V, VARTA CR ½ AA
Estimated life:	10 years from date of production of data logger

9.3.8 Electromagnetic compatibility

Device is tested in accordance with EN 61326-1: 2006 article 6 table 1

radiation:	EN 55022 ed. 2 class B
immunity:	EN 61000-4-2: class B (4/8 kV)
	EN 61000-4-3: class A (3V/m)
	EN 61000-4-4: class A (0,5/1 kV)
	EN 61000-4-5: class A
	EN 61000-4-6: class A (3 V)

9.3.9 Operating conditions

Operating temperature:	(0..50) °C
Operating humidity:	(5 .. 85) %RH
Settling time after switching ON:	15 minutes

9.3.10 Storing condition

Storing temperature:	-10 to +70 °C
Relative humidity:	(5 to 95) %RH

9.3.11 Mechanical parameters

Dimensions of the case:	215 x 165 x 60 mm without connectors and without mounting consoles 215 x 225 x 60 mm with DSub connectors with covers
Weight:	approximately 800 g
Protection:	IP20
Input terminals:	removable, maximum cross section of lead: 1.5 mm ²
Mounting:	desk top – standard version by means of two mounting consoles – optional accessory by means of DIN rail 35 mm holder – optional accessory

9.4 Technical parameters of inputs

Input modules are designed as individual replaceable units plugged in sockets behind connection terminals of input channels. Manufacturer does not recommend to replace modules by unskilled personnel.

Each input module is adjusted to fixed maximum measuring range, where it works correctly in specified limits of accuracy. Input modules contain part of protection circuitry, circuitry for signal unification and memory with stored calibration and configuration constants. With galvanic isolated inputs optical isolation of the signal by analog operational amplifier is used. User is not able to modify configuration of input modules. If needed user can recalculate measured value to desired real value with physical unit by means of a special menu item Recalculations in the PC program.

Galvanic isolated inputs have isolation strength of 500 V. It is not tested as safety isolation, see Not allowed manipulations and warning.

9.4.1 Input modules for measurement of dc voltage and currents

These input modules are available in version without galvanic isolation or as galvanic isolated (with the exception of A0 input). Input with galvanic isolation is marked by additional letter G behind its type name.

Time response to step change of input signal is negligible referred to logging interval (1 s).

Input module type A0	
Measured value:	dc current, se source two-wire connection transmitters powered from current loops
Range:	(4.. 20) mA
Accuracy:	0.1 % from range (± 0.02 mA)
Current in short circuit of input terminals:	limited to approximately 25 mA
Voltage across open terminals:	voltage source - 3V, at power 24V approximately 21V

Input module type A1 and A1G	
Measured value:	dc current
Range:	(4.. 20) mA
Accuracy:	0.1 % from range (± 0.02 mA)
Input resistance:	approximately 14 Ω
Overload capacity:	100 % (current ± 40 mA maximum)

Input module type B0 and B0G	
Measured value:	dc current
Range:	(0.. 20) mA
Accuracy:	0.1 % from range (± 0.02 mA)
Input resistance:	approximately 14 Ω
Overload capacity:	100 % (current ± 40 mA maximum)

Input module type B1 and B1G	
Measured value:	dc current
Range:	(0.. 1) A
Accuracy:	0.1 % from range (± 1 mA)
Input resistance:	approximately 0.04 Ω
Overload capacity:	± 5 A maximum

Input module type B2 and B2G	
Measured value:	dc current
Range:	(0.. 5) A
Accuracy:	0.1 % from range (± 5 mA)
Input resistance:	approximately 0.04 Ω
Overload capacity:	10% (current ± 5.5 A maximum)

Input module type D0 and D0G	
Measured value:	dc voltage
Range:	(0.. 100) mV
Accuracy:	0.1 % from range (± 0.1 mV)
Input resistance:	>10 M Ω
Overload capacity:	± 5 V maximum
Input module type D1 and D1G	
Measured value:	dc voltage
Range:	(0.. 1) V
Accuracy:	0.1 % from range (± 1 mV)
Input resistance:	>10 M Ω for input D1 >400 k Ω for input D1G
Overload capacity:	± 5 V maximum for input D1 ± 10 V maximum for input D1G
Input module type D2 and D2G	
Measured value:	dc voltage
Range:	(0.. 10) V
Accuracy:	0.1 % from range (± 10 mV)
Input resistance:	>1 M Ω
Overload capacity:	± 30 V maximum
Input module type D4 and D4G	
Measured value:	dc voltage
Range:	(0.. 75) V
Accuracy:	0.1 % from range (± 75 mV)
Input resistance:	>900 k Ω
Overload capacity:	± 100 V maximum (from safety aspect 75 V maximum)
Input module type D5 and D5G	
Measured value:	dc voltage
Range:	(-10.. +10) V
Accuracy:	0.1 % from range (± 20 mV)
Input resistance:	>1 M Ω (D5), >400 k Ω (D5G)
Overload capacity:	± 30 V maximum

9.4.2 Input modules for measurement of ac voltage and current

These input modules are produced always in version with galvanic isolation (without additional marking with letter G). These inputs contain RMS/DC converter, which is designed for measurement of signals with sine course. Specified measurement accuracies below are valid for sine signal with frequency 50 Hz.

General parameters of ac inputs		
non-sine signal:	symmetric rectangular 1:1	additional error 11%
	symmetric triangle	additional error – 4%
time response t_{90}	step from 0 to $3/4$ of range	approximately 2 s
	step from $3/4$ of range to 0	approximately 10 s

Input module type C0	
Measured value:	ac current
Range:	(0.. 20) mA
Accuracy:	1 % from range (± 0.2 mA)
Input resistance:	approximately 14Ω
Overload capacity:	100% (current 40 mA maximum),
Input module type C1	
Measured value:	ac current
Range:	(0.. 1) A
Accuracy:	1 % from range (± 10 mA)
Input resistance:	approximately $0.04\ \Omega$
Overload capacity:	5 A maximum
Input module type C2	
Measured value:	ac current
Range:	(0.. 5) A
Accuracy:	1 % from range (± 50 mA)
Input resistance:	approximately $0.04\ \Omega$
Overload capacity:	5,5 A maximum
Input module type E0	
Measured value:	ac voltage
Range:	(0.. 100) mV
Accuracy:	1 % from range (± 1 mV)
Input resistance:	$>10\ M\Omega$
Overload capacity:	5 V maximum
Input module type E1	
Measured value:	ac voltage
Range:	(0.. 1) V
Accuracy:	1 % from range (± 10 mV)
Input resistance:	$>10\ M\Omega$
Overload capacity:	5 V maximum
Input module type E2	
Measured value:	ac voltage
Range:	(0.. 10) V
Accuracy:	1 % from range (± 100 mV)
Input resistance:	$>1\ M\Omega$
Overload capacity:	50 in maximum
Input module type E4	
Measured value:	ac voltage
Range:	(0.. 50) V
Accuracy:	1 % from range ($\pm 0,5$ V)
Input resistance:	$>700\ k\Omega$
Overload capacity:	100 V maximum (from safety aspect only 50 V AC)

9.4.3 Input modules for measurement of resistance and resistance transmitters

These input modules are produced in version without galvanic isolation or galvanically isolated. Input with galvanic isolation is marked with additional letter G behind its type marking.

Time response to jump change of input signal is negligible refer to fastest sampling interval (1 s).

Modules are produced only for two-wire measurement. Possible error due lead lengths can be corrected by means of user conversions.

Input module type F and FG	
Measured value:	resistance
Range:	0.. user defined range (from 100Ω to 1 MΩ)
Accuracy:	0.1 % from range
Measuring current:	approximately $I = 1.25/\text{range}$ [A, Ω]
Maximum voltage on input:	± 5 V maximum
Input module type J and JG	
Measured value:	temperature from resistance sensor Nickel 1000/ 6180 ppm
Range:	(-50 .. 250) °C
Accuracy (without probe):	±0.2 °C at range (-50..100) °C, ±0.2 % from value at range (100 .. 250) °C
Measuring current:	approximately 0.25 mA (depends on temperature)
Maximum voltage on input:	± 5 V maximum
Input module type K and KG	
Measured value:	temperature from resistance sensor Pt100/ 3850 ppm
Range:	(-140 .. 600) °C
Accuracy (without probe):	±0.2 °C at range (-140..100) °C, ±0.2 % from value at range (100 .. 600) °C
Measuring current:	approximately two mA (depends on temperature)
Maximum voltage on input:	± 5 V maximum
Input module type K1 and K1G	
Measured value:	temperature from resistance sensor Pt1000/ 3850 ppm
Range:	(-140 .. 600) °C
Accuracy (without probe):	±0.2 °C at range (-140..100) °C, ±0.2 % from value at range (100 .. 600) °C
Measuring current:	approximately 0,2 mA (depends on temperature)
Maximum voltage on input:	± 5 V maximum
Input module type K3	
Measured value:	temperature from resistance sensor Pt1000/ 3850 ppm
Range:	(-10 .. 50) °C
Accuracy (without probe):	±0.06 °C
Measuring current:	approximately 0,2 mA (depends on temperature)
Maximum voltage on input:	± 5 V maximum

9.4.4 Input modules for temperature measurement from thermocouple transmitters

Inputs for measurement of thermocouple (except thermocouple type B) have compensation of cold junction temperature inside of data logger. Compensation *temperature is measured on data logger motherboard between terminals for channel 8 and channel 9*. Value of this temperature is converted to thermoelectric voltage and added to value of thermoelectric voltage measured by thermocouple. Result is converted to temperature again, which is resulting measured temperature. If using thermocouples operate data logger in working position with input signal terminals towards down and do not install heat sources in the **neighborhood**.

These input modules are produced in version without galvanic isolation or galvanically isolated. Input with galvanic isolation is marked with additional letter G behind its type marking.

Time response to jump change of input signal is negligible refer to fastest sampling interval (1 s).

Input module type N and NG	
Measured value:	temperature measured by thermocouple type K (Ni-Cr / Ni-Al)
Range:	(-70..1300) °C
Accuracy without probe:	± (0.3 % from measured value + 1,5 °C)
Cold junction:	compensated at temperature range (0..50) °C
Maximum voltage on input:	± 5 V maximum
Input module type O and OG	
Measured value:	temperature measured by thermocouple type J (Fe / Cu-Ni)
Range:	(-200..750) °C
Accuracy without probe:	± (0.3 % from measured value + 1,5 °C)
Cold junction:	compensated at temperature range (0..50) °C
Maximum voltage on input:	± 5 V maximum
Input module type P and PG	
Measured value:	temperature measured by thermocouple type S (Pt-10 % Rh / Pt)
Range:	(0..1700) °C
Accuracy without probe:	± (0.3 % from measured value + 1,5 °C)
Cold junction:	compensated at temperature range (0..50) °C
Maximum voltage on input:	± 5 V maximum
Input module type Q and QG	
Measured value:	temperature measured by thermocouple type B (Pt-30 % Rh / Pt-6 % Rh)
Range:	(100..1800) °C
Accuracy without probe:	± (0.3 % from measured value + 1 °C) at range (300..1800)°C
Cold junction:	not compensated
Maximum voltage on input:	± 5 V maximum
Input module type T and TG	
Measured value:	temperature measured by thermocouple type T (Cu / Cu-Ni)
Range:	(-200..400) °C
Accuracy without probe:	± (0.3 % from measured value + 1,5 °C)
Cold junction:	compensated at temperature range (0..50) °C
Maximum voltage on input:	± 5 V maximum

9.4.5 Input modules for counting pulses

Counter inputs are designed for counting of incoming pulses (gas meters, electrometers..). Modules contain own processor unit, which registers incoming pulses even if power is switched OFF (module has its own battery for power, if data logger is not switched ON). Record is performed similarly as with analog inputs, i.e. by writing counter value to data memory in adjusted logging interval. Value from counter can be displayed in absolute format or as recalculated, in record it is possible to display relative format as increments in logging intervals. Counter module contains switch-able overshoot filter (fast changes) of input pulses.

Input module CTU - galvanic isolated counter for voltage signal

Capacity of counter:	31 bits, activated by downward edge of input signal maximum value of counter: 2147483647
Input level:	state „L“: 0 to 0,8 V state „H“: 3 to 24 V maximum
Input current:	approximately 7 mA in state „H“
Input frequency:	0 to 5 Hz, length of pulse minimum 200 ms, if Filter is switched ON 0 to 5 kHz, length of pulse minimum 30 µs, if Filter is switched OFF
Galvanic isolated:	500 V, not designed for safety function
Battery life:	minimum 6 months, if data logger is switched OFF

Input module CTK - galvanic non-isolated counter for potential-less contact

Capacity of counter:	31 bits, activated by leading edge of input signal maximum value of counter: 2147483647
Input level:	state „L“: resistance of opened contact >250 k Ohms state „H“: resistance of closed contact < 10 k Ohms
Input frequency:	0 to 5 Hz, length pulse minimum 200 ms, if is Filter switched ON 0 to 5 kHz, length pulse minimum 30 µs, if is Filter switched OFF
Galvanic isolated:	module is not galvanic isolated from other circuitry of data logger
Battery life:	minimum 6 months, if data logger is switched OFF

9.4.6 Input modules for monitoring of binary event

Binary inputs serve for evaluation of two-state level input signals (contact closed/opened respectively voltage present/not present).

Input module S and SG - binary input for potential-less contact

Input level:	state „L“: resistance of opened contact >100 k Ohms state „H“: resistance of closed contact < 1000 Ohms
Minimum length of input pulse:	200 ms
Galvanic isolated:	only with input module SG: 500 V, not designed for safety function

Input module S1 - binary input for voltage level, galvanic isolated

Input level:	state „L“: 0 to 0,8 V state „H“: 3 to 30 V maximum
Input current:	(1..9) mA .. depending on applied input voltage in state „H“
Minimum length of input pulse:	200 ms
Galvanic isolated:	500 V, not designed for safety function

9.4.7 Input modules for measurement frequency

Module contains its own processor, processing measured values is identical as with analog inputs.

Input module FU - galvanic isolated input for measurement of frequency voltage signal	
Range:	0 to 5 kHz, duration of input pulse minimum 30 μ s
Resolution:	1 Hz
Accuracy:	\pm (0,2% from reading +1Hz)
Input level:	state „L“: 0 to 0,8 V state „H“: 3 to 24 V maximum
Input current:	approximately 7 mA in state „H“
Galvanic isolated:	500 V, not designed for safety function

Input module FK - galvanic non-isolated input for measurement of frequency of contact switching	
Range:	0 to 5 kHz, duration of input pulse minimum 30 μ s
Resolution:	1 Hz
Accuracy:	\pm (0,2% from reading +1Hz)
Input level:	state „L“: resistance of opened contact >250 k Ohms state „H“: resistance of closed contact < 10 k Ohms

9.4.8 Input RP - galvanically isolated input for transmitters with serial output RS485

This input module contains its own processor unit and serves for reading from intelligent transmitters, supporting basic form of protocol ModBus RTU or ADVANTECH. Data logger can contain several RP modules. For each input channel of data logger it is possible to select, which RP (or other) module measured values are getting from.

Input communication interface:	RS485
Address of input device:	must be from interval 1 to 247 (decimal)
Communication speed:	(1200, 2400, 4800, 9600, 19200, 57600, 115200) Bd
Parity:	1 stop bit with odd/even parity, 1 stop bit without parity, 2 stop bits without parity
Transfer protocol:	ModBus RTU, Advantech
Impedance of input (reception):	approximately 12 k Ohms
Maximum length of cable:	1200 m at indoor rooms
Galvanic isolated:	500 V, not designed for safety function

This input module can cooperate with 1 up to 16 devices (resp. measured points). The module works that way, command for reading of data from the first transmitter is sent, then it waits for the response. Maximum waiting time is possible to set to approximately 210 ms. After waiting time error of communication is reported and reading of next channel continues. If device responses in adjusted time, response is evaluated and also reading of next channel continues.

Note: *for more information see Appendix 3.*

© Copyright: COMET SYSTEM, s.r.o.

It is prohibited to copy and make any changes in this manual, without explicit agreement of company COMET SYSTEM, s.r.o. All rights reserved.

COMET SYSTEM, s.r.o. makes constant development and improvement of their products. Manufacturer reserves the right to make technical changes to the device without previous notice. Misprints reserved.

Contact the manufacturer of this device:

COMET SYSTEM, s.r.o.

Bezrucova 2901

756 61 Roznov pod Radhostem

Czech Republic

www.cometsystem.com